

 Infrico

frīBuffet

CATÁLOGO · CATALOGUE

20
24



Más allá del *concepto* de Buffet

Beyond the buffet concept



frIBuffet

En el Grupo Infrico uno de nuestros pilares siempre ha sido la innovación buscando soluciones a diferentes necesidades de nuestros clientes, siempre cuidando el diseño, la eficiencia y el cuidado del medio ambiente. En la actualidad el sector HORECA está en un proceso de renovación y nosotros estamos comprometidos con ello.

Fribuffet está enfocada a mejorar el servicio de buffet y comida preparada para la conservación en caliente, neutro y frío de los alimentos, siempre manteniendo la calidad y propiedad de los alimentos. Además, apostamos por la comodidad de los usuarios finales gracias al diseño de los diferentes tipos de mobiliario.

En Infrico hemos creado diferentes muebles atendiendo las necesidades de cada establecimiento. Por ello encontramos elementos de calor o frío y una gran variedad de componentes y accesorios que completan esta línea. Con la principal misión de mantener la integridad y cualidades de cada alimento, así como exponerlos de la forma más apetecible. Todo ello siempre con la máxima calidad y tecnología del Grupo Infrico.

Fribuffet es una apuesta segura por la innovación y el diseño con marca España, inspirada en los mayores estándares de calidad, eficiencia energética y cuidado del medio ambiente, así como en el diseño ergonómico pensado para el usuario.

Desde Infrico estamos comprometidos con la sociedad. Por ello hemos invertido mucho esfuerzo en I+D+ I aplicando la última tecnología en la fabricación de los equipos de Fribuffet ofreciendo diferentes soluciones a las necesidades del mercado. Grupo Infrico al ser una empresa global permite atender a empresas presentes por todo el globo, dando servicio en todos los continentes y cubriendo las necesidades de los clientes más exigentes.

At Grupo Infrico, one of our main pillars has always been innovation, seeking solutions to the different needs of our customers, taking care of design, efficiency, and the environment.

At present, the Horeca sector is living a renovation process, and we are committed to it. Fribuffet is focused on improving the service of buffet and food ready to be heat, neutral and cold preserved, always maintaining the quality and properties of the product. Furthermore, we have a strong commitment to the end users' comfort, resulting in the design of different types of equipment.

As an answer to the needs of each establishment, we have created different devices which consist of heating or cooling elements and a wide range of components and accessories that complete them. All of these with the sole mission of maintaining the qualities and integrity of food and exhibiting it in the most appealing way, always with the highest quality and latest technology that Grupo Infrico is known for.

Fribuffet is a safe bet for innovation and design made in Spain, inspired by the highest standards of quality, energy efficiency and environmental care, as well as ergonomic user-oriented design.

At Infrico we are committed to present-day society. Therefore, we have invested a lot of effort in R&D, applying the latest technology in the production of Fribuffet equipment, offering different solutions to the needs of the market.

Being a global company, Grupo Infrico is able to help other companies all over the world, providing our services in every continent and meeting the needs of the most demanding customers.

NOVEDADES

WHAT'S NEW

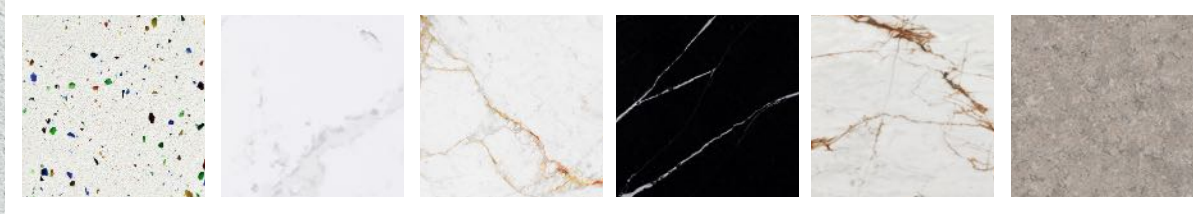

DECORACIONES

Pag.00



SELF SERVICE

Pag.00



BAR STATION

Pag.00



ESTRUCTURA DE PANTALLAS

Pag.00

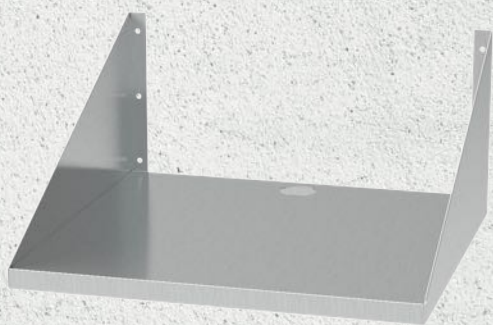

ELEMENTOS NEUTROS

Estanterías de Pared · Wall Shelves

Pag.00



ACCESORIOS

Lámparas de calor · Heat lamp

Pag.00

Í

Í

Í

Í

Í

Í

Í

Í

Í

Í

INDEX



one washed
euro liner

ME

Cap. 1	Empresa <i>Company</i>	Pag.00
Cap. 2	Contract <i>Contract</i>	Pag.00
Cap. 3	Basic Buffet <i>Basic Buffet</i>	Pag.00
Cap. 4	Gastrobuffet <i>Gastrobuffet</i>	Pag.00
Cap. 5	Encastrables <i>Dropin</i>	Pag.00
Cap. 6	Self Service <i>Self Service</i>	Pag.00
Cap. 7	Bar Station <i>Bar Station</i>	Pag.00
Cap. 8	Carros calientes y fríos <i>Banquet Trolley</i>	Pag.00
	Elementos Neutros <i>Neutral Elements</i>	Pag.00
	Accesorios <i>Accesorios</i>	Pag.00



EMPRESA Company

INFRICO nace en 1986 con un objetivo claro: generar las mejores soluciones de refrigeración adaptadas a las necesidades específicas de cada cliente. **Vanguardia tecnológica, calidad certificada y la excelencia de sus productos son las garantías** que avalan su compromiso de innovación y que la han posicionado como líderes absolutos en el sector del equipamiento del frío comercial. La empresa ofrece una muy amplia gama de maquinaria que abarca todo lo relacionado con el frío para el sector **HORECA**, panadería, pastelería, heladería, catering y también **Supermarket**, mediante su línea específica,

a través del frío. También el sector biomédico y de laboratorio con su prestigiosa línea Infrico Medcare. Con clientes en todo el mundo y una gran cuota demercado nacional, la compañía, que se encuentra en un continuo proceso de crecimiento y expansión, cuenta en la actualidad con más de quinientosempleados repartidos en 13 delegaciones en España y 16 en el extranjero. Además, en una firme apuesta por la estabilidad y el bienestar social, más del 90% de los trabajadores son empleados fijos. Infrico posee el Certificado de Origen Español Certificado (O.E.C.) que acredita

que sus productos son fabricados en España, convirtiéndose así en la primera compañía del sector que logra este sello en nuestro país, tras superar con éxito su exhaustivo proceso de auditoría. Sus centros de producción ubicados en Lucena, en la provincia de Córdoba, son unas de las instalaciones industriales más modernas de España. Tres plantas, Infrico, Infrico Supermarket e Impafri, que cuentan con una superficie total de 160.000 metros cuadrados destinados a producción, actividades logísticas y oficinas.



160.000 m2 dedicados a la fabricación de equipos de refrigeración comercial de última generación
160.000 m2 dedicated to the manufacture of comercial refrigeration equipment of last generation



16 Delegaciones
16 Delegations



CSA

GRUPO Infrico®

INFRICO was born in 1986 with a clear objective: to generate the best cooling solutions adapted to the specific needs of each client. Technological vanguard, certified quality and the excellence of its products are the guarantees to support its commitment to innovation and that have positioned it as absolute leaders in the commercial refrigeration equipment. The company offers a very wide range of machinery that covers everything related to cold for the HORECA sector, bakery, pastry, ice cream, catering and also Supermarket, through its specific line,

thanks to cold. Also, the biomedical and laboratory sector, with its prestigious Infrico Medicare line. It has customers around the world and a large share of the national market, the company, which is in a continuous process of growth and expansion, currently has more than five hundred employees spread across 13 delegations in Spain and 16 abroad. In addition, in a firm commitment to stability and social welfare, more than 90% of workers are permanent employees. The company has Spanish Origin Certificate (S.O.C.) that certifies that its products are manufactured in Spain,

thus becoming the first company in this sector in Spain to achieve this seal after successfully completing its exhaustive audit process. The Production Centers are located in Lucena, in the province of Cordoba, they are one of the most modern industrial facilities in Spain. Three plants that have a total area of 160.000 square meters for production, logistics activities and offices.



Nuestro equipo: nuestra mayor riqueza

En Infrico fabricamos máquinas, pero lo que más nos importa son las personas. La mayor riqueza de Infrico es nuestro equipo y lo cuidamos como se merece porque sabemos que, de la felicidad de nuestros colaboradores, depende la capacidad productiva de nuestra organización.

La compañía posee el Certificado de Origen Español Certificado (O.E.C.) que acredita que sus productos son fabricados en España, convirtiéndose así en la primera compañía del sector en España que logra este sello tras superar con éxito su exhaustivo proceso de auditoría.

Sus Centros de Producción están ubicados en Lucena, en la provincia de Córdoba, son unas de las instalaciones industriales más modernas de España. Tres plantas que cuentan con una superficie total de 160.000 metros cuadrados destinados a producción, actividades logísticas y oficinas.

Comprometidos con la sociedad

En Infrico queremos contribuir al progreso de la sociedad y lo hacemos como mejor sabemos, aplicando la última tecnología en I+D+i a la fabricación de equipos de frío industrial que ofrezcan soluciones garantizando el bienestar y velando por la salud y la seguridad alimentaria. Además, somos conscientes de nuestra

responsabilidad social como agente económico y motor de desarrollo. Generamos riqueza a través de la creación de puestos de trabajo de calidad y además colaboramos con diversas causas sociales para contribuir, con

nuestro apoyo, a la creación de un entorno más favorable con aquellos que más sufren.

Comprometidos con la innovación

Las buenas ideas son la clave del éxito. Infrico realiza un constante esfuerzo en innovación y mejora de nuestros equipos, una apuesta que ha sido certificada y reconocida con distinciones y premios internacionales. Por eso, nuestra compañía es la primera empresa del sector en estar acreditada por un sistema de gestión de la calidad basado en la norma ISO 9001:2015, que engloba toda la maquinaria de su catálogo.

Comprometidos con el Medio Ambiente

En el trabajo diario, además de responder a las necesidades de sus clientes, en Infrico prestamos especial



Responsabilidad SOCIAL

Corporate Social Responsibility

atención a las iniciativas que contribuyan al desarrollo de una industria sostenible y respetuosa con el medio ambiente, mediante una correcta administración de los recursos naturales, el adecuado tratamiento de los residuos y el reciclaje y la reutilización de materiales.

Estamos muy orgullosos de haber superado con éxito los exhaustivos procesos de auditoría que demuestran que nuestro compromiso con el mantenimiento del medio ambiente es una realidad avalada por los expertos en la defensa y protección de nuestro planeta.

En Infrico, además, somos pioneros en la implantación del gas R290, un refrigerante verde que no contamina y que minimiza el consumo de energía eléctrica. Lo incorporamos en nuestros equipos e impartimos cursos de formación con buenas prácticas sobre como manipular el mismo.



Our team: our greatest wealth

At Infrico we manufacture machines, but people are what matters most to us. The greatest wealth of Infrico is our team and we take care of it as it deserves, knowing how we are that the productive capacity of our organization depends on our team.

The company has the Spanish Origin Certificate (S.O.C.), testifying that its products are manufactured in Spain, thus becoming the first company in this sector in Spain to achieve this seal after successfully completing its exhaustive audit process.

The Production Centers are located in Lucena, in the province of Cordoba. They are one of the most modern industrial facilities in Spain. It has three plants with a total area of 160,000 square meters for production, logistics activities and offices.

We are committed to society

In Infrico, we want to contribute to the progress of society and we do it as we know best, applying the latest technology in R+D+i to the manufacture of cold industrial equipment that offer solutions guaranteeing well-being and ensuring health and food safety.

In addition, we are aware of our social responsibility as an economic agent and driving force of development. We generate wealth through the creation of quality jobs and also collaborate with various social causes to contribute, with

our support, to the creation of a more favorable environment with those who suffer the most.

We are committed to innovation

Good ideas are the key to success. Infrico makes a constant effort in innovation and improvement of our equipment, a bet that has been certified and recognized with international awards and distinctions. That is why our company is the first company in the sector to be accredited by a quality management system based on the ISO 9001: 2015 standard, which encompasses all the machinery of its catalog.

We are committed to the environment

In daily work, in addition to responding to the needs of its customers, Infrico pay special attention to initiatives that contribute to the development of a sustainable and environmentally friendly industry, through proper management of natural resources, the appropriate treatment of waste and recycling and the reuse of materials.

We are very proud to have successfully completed the exhaustive audit processes that demonstrate that their commitment to the maintenance of the environment is a reality endorsed by experts in the defense and protection of our planet.

We are also pioneers in the implementation of R-290 gas

a green refrigerant that does not pollute and that minimizes the consumption of electricity. We incorporate it into our equipments and impart training courses with good practices on how to manipulate it.



Respeto al **MEDIO** AMBIENTE

Respect for the environment

Infrico, siguiendo con su política de respeto y conservación al medio ambiente, está Certificado en la norma internacional de Medio Ambiente ISO 14001:2015.

Controlamos el cumplimiento de todos los requisitos legales y ponemos en práctica políticas de reducción de recursos naturales, reciclaje y gestión de residuos.

Comprometidos con el diseño ecológico, y la disminución del consumo energético.

Uso de compresores de alta eficiencia energética y bajo nivel sonoro. Aislamiento de poliuretano inyectado a alta presión libre de CFC's con densidad de 40 Kg/m³.

Cumplimos la Directiva RoHS (2011/95/UE), en virtud de la cual "Declaramos que nuestros productos cumplen, referente a la restricción del uso de determinadas sustancias peligrosas en aparatos eléctricos y electrónicos, tales como el plomo, mercurio, cadmio, cromo hexavalente, bifenilos polibromados y difeniléteres polibromados en determinadas concentraciones".

Following its policy of respect and conservation of the environment, Infrico is certified in the international environmental standard ISO 14001:2015.

We control compliance with all legal requirements and implement policies to reduce natural resources, recycling and waste management.

We are committed to ecological design, and the reduction of energy consumption.

We use compressors with high energy efficiency and low noise level. Polyurethane insulation injected at high pressure free of CFC's with density 40 Kg/m³.

We comply with the RoHS Directive (2002/95/UE), so "We declare that our products comply, regarding the restriction of the use of certain dangerous substances in electrical and electronic equipment, such as lead, mercury, cadmium, hexavalent chromium, polybrominated biphenyls and polybrominated diphenyl ethers in certain concentrations".

Condiciones generles de

VENTA

General sales conditions

Garantía

Según el CERTIFICADO DE GARANTÍA que acompaña a cada producto.

Pedidos

Las solicitudes de pedido deberán dirigirse a nuestras instalaciones centrales de Infrico, S.L. o a nuestras delegaciones. Los pedidos no podrán anularse cuando se haya efectuado la expedición del material.

Si el material es de fabricación especial, no se admitirá la anulación una vez que se haya comenzado la fabricación. Queda reservado el derecho a admitir pedidos de aquellos clientes que hayan incumplido anteriores contratos. Las condiciones particulares que se citen en el pedido del cliente quedarán anuladas si no se ajustan a las presentes condiciones generales de venta o que se acepten expresamente.

Portes

Los portes serán pagados cuando viajen con nuestros medios. En caso contrario o por urgencia del cliente serán a portes debidos. Nuestros almacenes reexpedirán el material a portes debidos. En ambos casos, la mercancía viajará por cuenta y riesgo del comprador.

Guarantee

According to the CERTIFICATE OF GUARANTEE that accompanies each product.

Orders

The order requests should be directed to our Infrico, S.L. central offices or to our delegations. The orders will not be able to be annulled when the expedition of the material has been performed. If the material is of special production, annulment will not be admitted once the production has begun. We reserve the right to admit orders from those clients that have broken previous contracts. The particular conditions that are cited in the client's order will remain annulled if they are not adjusted to the present general conditions of sale or explicitly accepted.

Transport

The postage will be paid when they travel with our means. Otherwise, or by urgency of the client, the postage will be owed. Our stores will re-issue the material to postage owed. In both cases, the merchandise will travel at risk of the buyer.

Packaging

Infrico standard packaging is included.

Prices

The prices that figure in the present rate are PUBLIC SALE PRICES

Embalaje

Estándar de Infrico incluido en el precio.

Precios

Los precios que figuran en la presente tarifa son PRECIOS VENTA PÚBLICO y en nuestras instalaciones centrales o almacenes de distribución. Los impuestos en vigor se cargarán en la factura correspondiente. Los descuentos aplicables a los elementos opcionales serán el equivalente al descuento estipulado para el catálogo de repuestos, excepto cajones y cerraduras cuando estos vayan incorporados al mueble.

Formas de pago

El pago de las facturas se realizará al contado en nuestras instalaciones centrales o delegaciones, salvo que se otorgue crédito al cliente. En este caso, se efectuará el pago en la forma y lugar convenidos.

Si antes o durante la cumplimentación de un pedido se produjesen circunstancias que pudieran originar incumplimiento en los pagos, se podrá demorar la entrega de la mercancía mientras el comprador no anticipe o avance el pago de los mismos.

Devoluciones

No se admitirán devoluciones de material salvo que expresamente sea autorizada por Infrico. En todo caso, el material debe remitirse libre de portes y gastos.

Recambios y accesorios

No se admitirán devoluciones salvo autorización expresa del S.A.T.

Litigios

En este caso serán competentes los Tribunales de Lucena (Córdoba).

and in our central installations or stores of distribution. The taxes in vigour will be charged in the corresponding invoice. The discounts on the optional elements will be the equivalent to the spare catalogue discounts, except drawers and locks when incorporated to the product.

Forms of payment

The payment of invoices will be carried out cash down in our central installations or delegations, unless credit is offered al client. In this case, the payment will be carried out in the form and place agreed upon. If, before or during the completion of an order, circumstances are produced that could originate a breach in the payments, the delivery of the merchandise will be delayed while the buyer does not anticipate or guarantee the payment.

Returns

Not returns of any material will be admitted unless explicitly authorized by Infrico. In any case, the material should be remitted free of postage and expenses.

Spares parts and accessories

Infrico standard packaging is included.

Lawsuits

In this case, they will be competent in the Courts of Lucena (Córdoba).

DELEGACIONES NACIONALES

National delegations



INFRICO S. L.

Oficina Central / *Main Office*

Ctra. de Aguilar a A-318 por Moriles, Km 15,5 - A-3132. CP 14900 LUCENA, Córdoba, España

Tel: +34 957 51 30 68 · Tel: +34 957 59 11 83 · mail: info@infrico.com

Jefe de Ventas / *Sales Manager*

Luis Rivas Montalvo · Tel: 650 43 65 87 · luisrivas@infrico.com

ARAGÓN

Adolfo Bueno

653 85 70 60

buenozaragoza@gmail.com

CASTILLA-LEÓN Y ASTURIAS

Paulino Canga González

609 66 52 54 · 670 59 49 86

paulo@delegadoastur.com

CATALUÑA - ANDORRA

Raúl Ballano · María José Verdú

Nacho Garat · ITECNIC, S.L.

93 562 61 52 · 93 562 61 45

info@itecnic.com

CANARIAS

Carlos Vega · DICAfri, S.L.

674 88 30 40 · 928 70 10 87

comercial@dicafri.es

BALEARES

Manuel Castro Baños

628 67 18 97

mcastro@infrico.com

GALICIA

Juan José Espejo Colmenero

609 85 01 55

escohostel@escohostel.com

SEVILLA, HUELVA Y CÁDIZ

José Manuel Romana

654 50 98 40

joமானueldibeca@hotmail.com

CÓRDOBA, JAÉN, MÁLAGA

CEUTA, MELILLA

Miguel Cantero

620 29 82 82

miguelcantero@infrico.com

MADRID Y ZONA CENTRO

Javier López

Alberto Moreno

J.M. Castellanos

91 684 60 96 · 682 68 21 25 · 91 684 61 06

delegacioncentro@infrico.com

PAÍS VASCO, NAVARRA, LA

RIOJA Y CANTABRIA

Mikel Pérez De Viñaspre

650 25 56 34

mikelperez@infrico.com

EXTREMADURA

Manuel Pérez Guisado

670 03 23 56 · 924 45 61 91

manuel@representacionesmpg.com

GRANADA, ALMERÍA Y MURCIA

Daniel Riquelme Cordero

659 85 04 15

danielriquemecordero@hotmail.com

VALENCIA, ALICANTE,

CASTELLÓN Y ALBACETE

Victoria Oliver / Elena Oliver

SILVINO OLIVER, S.L.

963 97 02 45 · 605 09 75 40

infricovalencia@silvinooliver.com



INTERNACIONALES

International delegations

Director Comercial / *Commercial Director*

Fran Ramón · +34 609 21 81 94 · framon@infrico.com

NORTH AMERICA

Pedro Carvajal
+34 690 23 44 78
pcarvajal@infrico.com

CANADA

AXOM GROUP
Xavier Lavigne
+1 514-825-2966
xavier@axomgroup.ca
Christian van den Hoven
+1 604-889-2966
chris@axomgroup.ca

INFRICO USA

Carlos Ortega
1.855.340.4637
sales@infrico.com

MÉXICO

Francisco Pedroche Sinergias
+33 3630 4547
+33 3615 7926
ventas@sinergiasmx.com

LATINOAMÉRICA

Antonio Mendoza
+34 682 65 57 84
amendoza@infrico.com

PANAMÁ

Juan Gabriel Martínez
+507 6676 8092
jmartinez@equipcopanama.com

REPÚBLICA DOMINICANA

Rafael Podadera
Parlyn Internacional
+ 18097594424
podadera.rafael@gmail.com

PUERTO RICO

Alexandre Vargas
Global Kitchen Solutions
+1 787 923 9365
alexandre@globalkitchensolutions.com

COLOMBIA

Fernando Toro López
+57 313 452 1306
ftoro@infrico.com

ECUADOR · PERÚ · BOLIVIA

Giovanni Pedrazzoli
+59 399 118 6962
gpedrazzoli@infrico.com

CHILE

Josué Meléndez
Comercial Maquinet
+56 9 8199 3973
ventas@maquinet.cl

NORTH EUROPE

Rafael Cañada
rafael@infrico.com

CENTRAL / EAST

EUROPE
Dragan Cerkez
+34 608 808 971
dragan@infrico.com

BENELUX / UK

SOUTH AFRICA
Mark Botwright
+34 679 71 93 26
mark@infrico.com

ITALIA

Roberto Doval
+34 606 970 357
rdoval@infrico.com

SUIZA / SWITZERLAND

Remzi Alili
Resan Enfrico Sàrl
+ 41 79 589 32 01
+ 41 21 671 70 70
resanenfrico@resanenfrico.ch

PORTUGAL

Rui Vigo
Unipessoal Lda. Rui Vigo
+ 351 915 283 253
+ 351 309 955 122
rui.vigo@netcabo.pt

MIDDLE EAST / UAE DUBAI /

INDIA

Sushil Hiranandani
+971528 496385
middle-east@infrico.com

INFRICO MAROC /

ÁFRICA / ARABIA SAUDI

Aziz Bouhartan
+ 212 661 107 372
+ 212 522 207 372
aziz.bouhartan@infrico.com

TURKEY / ASIA OCC

Dogan Bademkiran
+ 90 545 583 6315
dogan@infrico.com

ASIA / PACIFIC

Rafael Pérez
+34 620 000 938
rperez@infrico.com

FRANCIA

ZAC des Portes d L'Océane OUEST.
72650 Saint Saturnin (France)
Tel: 02 43 42 00 33 - 02 43 42 28 07
Direction Administrative
Sophia Choukri
06 58 04 33 15
sophia@infrico.com



CASTILLA-LEÓN · ASTURIAS
PAULINO CANGA GONZÁLEZ



GALICIA
JUAN JOSÉ ESPEJO · BRAIS ESPEJO



MADRID Y ZONA CENTRO
JAVIER LÓPEZ



EXTREMADURA
MANUEL PÉREZ GUISSADO



CÓRDOBA · JAÉN · MÁLAGA
MIGUEL CANTERO



SEVILLA · HUELVA · CÁDIZ
JOSE MANUEL ROMANA DÍAZ



CANARIAS
DICA FRI, S.L.



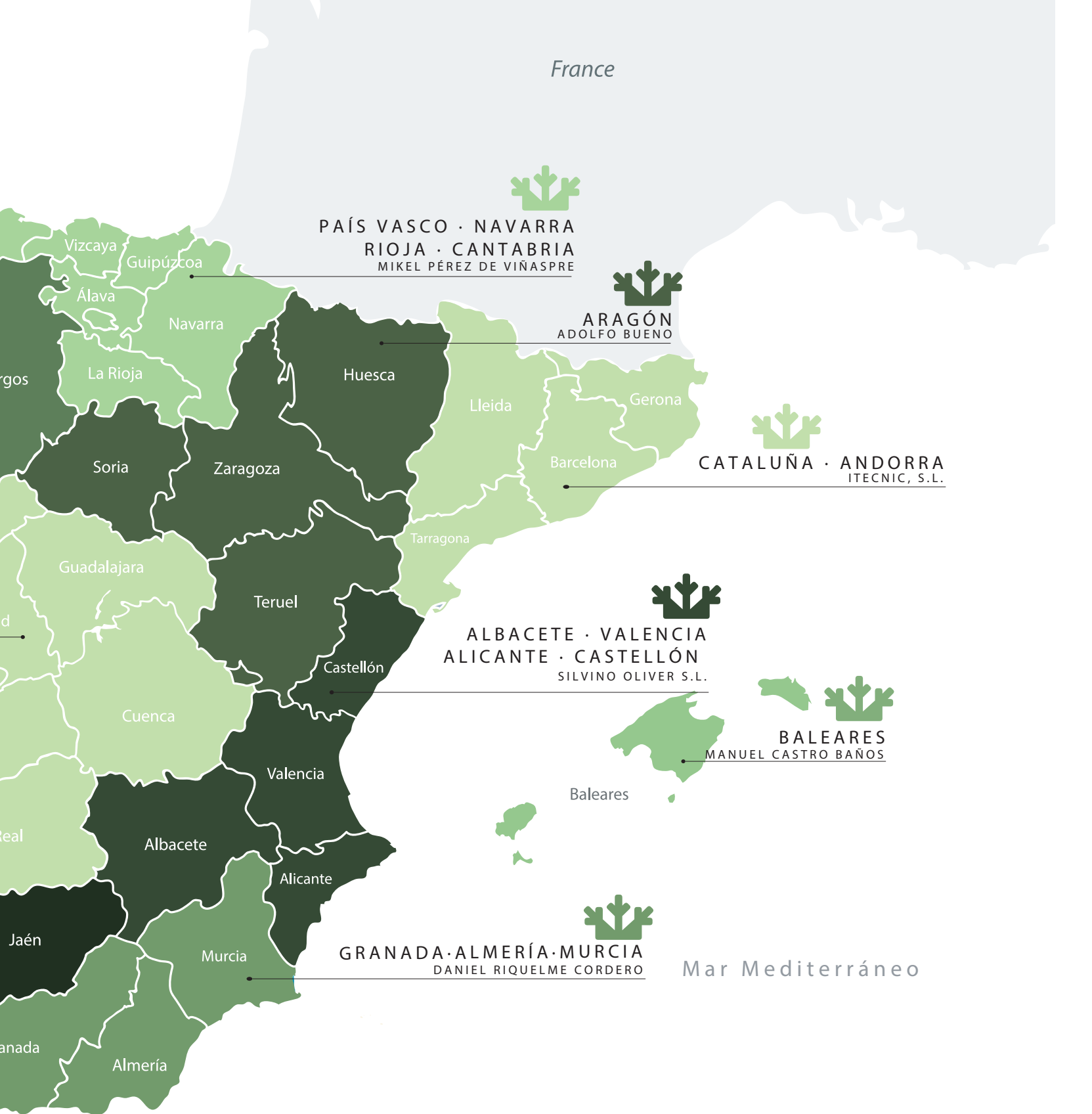

France

PAÍS VASCO · NAVARRA
RIOJA · CANTABRIA
MIKEL PÉREZ DE VIÑASPRE



ARAGÓN
ADOLFO BUENO



CATALUÑA · ANDORRA
ITECNIC, S.L.



ALBACETE · VALENCIA
ALICANTE · CASTELLÓN
SILVINO OLIVER S.L.



BALEARES
MANUEL CASTRO BAÑOS



GRANADA · ALMERÍA · MURCIA
DANIEL RIQUELME CORDERO



Mar Mediterráneo



LUIS RIVAS MONTALVO
JEFE DE VENTAS · SALES MANAGER
OFICINA CENTRAL · MAIN OFFICE

friBuffet

PRESENTES EN EL MUNDO





NORTE DE EUROPA
RAFAEL CANADA

EUROPA DEL ESTE
DRAGAN CERKEZ

TURQUIA-ASIA CENTRAL
DOGAN BADEMKIRAN

ORIENTE MEDIO-INDIA-EGIPTO
SUSHIL HIRANANDANI

ASIA-PACIFICO
RAFAEL PÉREZ

JAPÓN
FRAN RAMÓN



FRAN RAMÓN
DIRECTOR COMERCIAL · COMMERCIAL DIRECTOR
OFICINA CENTRAL · MAIN OFFICE



CONTRA

Contract



ACT

Fribuffet, marca comercial de Infrico es sinónimo de diseño de vanguardia, tecnología y máxima calidad. Nos avala una dilatada experiencia en la fabricación de productos de frío comercial. Entre otras cosas, porque nos volcamos en dar respuesta a las demandas de hasta los clientes más exigentes.

Siempre de la mano de los mejores materiales y respetando estrictos controles de calidad internos. Es esto lo que nos permite ofrecer al cliente los más altos estándares de calidad.

El equipo contract y comercial de Fribuffet, destaca por su trato directo e innovación en soluciones. Por brindar una atención al cliente que permite captar sus necesidades y deseos ya desde el principio. De hecho, una de nuestras señas de identidad es la adaptabilidad a las necesidades cliente.

En Fribuffet aunamos calidad, funcionalidad y diseño. Todo para que profesionales como arquitectos o interioristas confíen en nosotros para sus proyectos. Para que tengan claro que nuestros productos, sus ideas y diseños son la mejor elección. La tecnología de última generación y diseños de mueble adaptado nos permite ofrecer un abanico amplio de posibilidades, permitiendo a diseñadores, decoradores y arquitectos dar forma a ambientes con un estilo único y 100% funcionales.

En Fribuffet todos nuestros productos responden a los máximos estándares de calidad. Diseños únicos con una larga vida útil y que encajarán a la perfección en todo tipo de ambientes. Para ello, analizaremos previamente las posibilidades que ofrece el espacio para ofrecer al cliente la mejor alternativa.

Fribuffet, Infrico's trademark, is synonymous with avant-garde design, technology and the highest quality. We are backed by extensive experience in the manufacture of commercial refrigeration products. Among other things, because we devote ourselves to responding to the requirements of even the most demanding customers. Always working hand in hand with the best materials and respecting strict internal quality controls. This is what allows us to offer the customer the highest quality standards.

The Fribuffet contract and commercial team stands out for its direct treatment and innovation in solutions. For providing customer service that allows us to capture their needs and desires from the beginning. In fact, one of our hallmarks is adaptability to customer needs.

At Fribuffet we combine quality, functionality and design. Everything so that professionals such as architects or interior designers trust us for their projects. So that they are clear that our products, their ideas and designs are the best choice. State-of-the-art technology and adapted furniture designs allow us to offer a wide range of possibilities, allowing designers, decorators and architects to shape environments with a unique style and 100% functional.

At Fribuffet all our products meet the highest quality standards. Unique designs with a long useful life and that will fit perfectly in all kinds of environments. To do this, we will previously analyse the possibilities offered by the space to offer the client the best alternative.

GASTROBUFFET

A MEDIDA *custom-made gastrobuffet*



Nuestros Gastrobuffet están diseñados y pueden adaptar sus modelos estándar a cualquier espacio y tipo de Hotel o restaurante. Se hace de forma personalizada según las necesidades de cada cliente y previo estudio de viabilidad, para lograr que la instalación sea funcional, de calidad y se integre en el ambiente decorativo.

Se dispone de unas opciones especiales:

- Opción mural.
Dependiendo de la distribución y la composición, si no se pueden dejar 10cm de separación con la pared, se puede considerar la opción mural.
- Cuadro de mandos en el frontal.
Para mayor accesibilidad se puede situar el cuadro de mandos en la parte delantera del equipo.
- Modelos a medida.
- Configurar cualquier tipo de composición especial para adaptar las características del buffet a las necesidades de cada cliente.
- Consultar cualquier otra consideración especial.

Our Gastrobuffet are designed and can adapt their standard models to any space and type of hotel or restaurant. It is done in a personalized way according to the needs of each client and previous feasibility study, to ensure that the installation is functional, quality and integrated into the decorative environment.

Special options are available:

- Mural option.
Depending on the distribution and composition, if 10cm of separation cannot be left with the wall, the mural option can be considered.
- Control panel on the front.
For greater accessibility, the dashboard can be placed at the front of the equipment.
- Custom models.
Configure any type of special composition to adapt the characteristics of the buffet to the needs of each client.
- Consult any other special considerations.



DISEÑA TU ESPACIO

Desing your space





PERSONALIZACIÓN DE ACABADOS

Finish Customization

Trabajamos con los mejores fabricantes de piedra y adaptamos nuestros modelos a las necesidades y diseños del cliente.

We work with the best stone manufacturers and adapt our models to the customer's needs and designs.



Compac Venecia



Coverlam Serie Calacata



NEOLITH Abu Dhabi White



Cosentino Silestone Et Marquina



Cosentino Dekton Awake



Cosentino Dekton Vk03 Grigio



GASTROBUFFET AMERICANO

American gastrobuffet

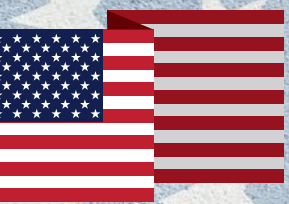

Adaptacion a todo tipo de medidas del mercado americano. Diferentes profundidades y estructuras (BSI).

Adaptation to all sizes of the American market. Different depths and structures (BSI).

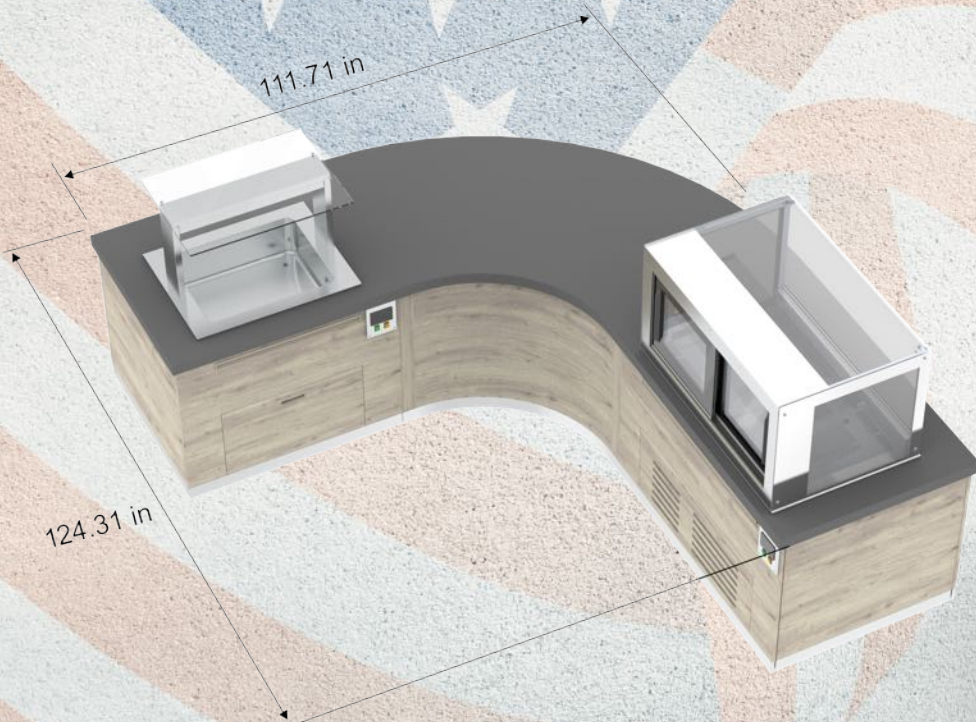

SNEEZE GUARD





BZ



Basic Buffet

MBUB4BM



Básico y *encantador*

basic & charming





CARÁCTERÍSTICAS GENERALES

GENERAL CHARACTERISTICS

- Módulos estándar de color blanco, también está la posibilidad de tener el cuerpo en gris antracita y en inox. Las decoraciones están disponibles en varios colores y varios acabados en madera, también existe la posibilidad de poner decoraciones más largas.
- Ruedas de serie para su desplazamiento.
- Capacidades disponibles en 2GN, 3GN y 4GN con amplia variedad de drop in.
- Pantallas disponibles: iluminación, infrarrojos e iluminación más infrarrojos.
- Posibilidad de colocar correbandejas a ambos lados del mueble y a diferentes alturas.

- *Standard modules of white color, there is also the possibility of having the body in anthracite gray and stainless steel. The decorations are available in various colors and various finishes in wood, there is also the possibility of putting longer decorations.*
- *Standard wheels for movement.*
- *Capacities available in 2GN, 3GN and 4GN with a wide variety of drop in.*
- *Available displays: illumination, infrared and illumination plus infrared.*
- *Possibility of placing trays on both sides of the furniture and at different heights.*



COLOR STANDAR: Blanco

OPCIONAL: Gris antracita (Sin incremento de precio)

INOX AISI 304 (Con incremento de precios)

STANDARD: White color

OPTIONAL: Gray · AISI 304 STAINLESS STEEL

EJEMPLO DE BASIC BUFFET

BASIC BUFFET EXAMPLE

1. Seleccionar los módulos (calor, frío o neutro) y su longitud (2GN, 3GN o 4GN)
2. Indicar el acabado del cuerpo y de las decoraciones.
3. Seleccionar los soportes con pantalla y los cristales.

1. *Select the modules (heat, cold or neutral) and their length (2GN, 3GN or 4GN)*
2. *Indicate the finish of the body and decorations.*
3. *Select the supports with screen and the crystals.*

EJEMPLO DE BASIC BUFFET

BASIC BUFFET EXAMPLE



Ejemplo 1

- Modelo: MBUB4CF
- Cuerpo estándar
- Decoración madera Anniversary 020AK
- Estante inferior
- Soporte pantalla: EEECU1 (1 altura)
- Vidrio superior: EEVSU1500
- Pantallas: EEKIU1500 (iluminación)
- Correnbandejas a una cara

Example 1

- Model: MBUB4CF
- Standard body
- Decoration wood Anniversary 020AK
- Bottom shelf
- Screen support: EEECU1 (1 height)
- Top glass: EEVSU1500
- Displays: EEKIU1500 (lighting)
- Tray runner on one side



Ejemplo 2

- Modelo: MBUB4CF
- Cuerpo gris antracita
- Decoración madera Anniversary 030AK
- Soporte pantalla: EEECU2 (2 altura)
- Vidrio superior: EEVSU1500
- Vidrio frontal: EEVFU1500
- Estante cristal: EEVEU1500
- Pantallas: EEKIU1500 (iluminación)
- Correnbandejas a dos caras

Example 2

- Model: MBUB4CF
- Anthracite grey body
- Decoration wood Anniversary 030AK
- Screen support: EEECU2 (2 height)
- Top glass: EEVSU1500
- Front glass: EEVFU1500
- Crystal bookcase: EEVEU1500
- Displays: EEKIU1500 (lighting)
- Tray runners on both sides



Ejemplo 3

- Modelo: MBUB4CF
- Cuerpo inox
- Decoración en color negro RAL 9017 y más larga
- Soporte pantalla: EEECU1 (1 altura)
- Vidrio superior: EEVSU1500
- Pantallas: EEPCU1500 (ciega)

Example 3

- Model: MBUB4CF
- Stainless steel body
- Decoration in black RAL 9017 and longer
- Screen support: EEECU1 (1 height)
- Top glass: EEVSU1500
- Displays: EEPCU1500 (blind)

Basic Buffet Baño María · Basic Buffet Bain Marie

Modelos · Models



MBUB2BM



MBUB3BM



MBUB4BM



MODELO Models	PRECIO Price	MEDIDAS Measures (mm)	TEMPERATURA Temperature (°C)	TENSIÓN -FRECUENCIA Electrical Data	CUBETAS Tank	POTENCIA Power (W)
MBUB2BM	1.682 €	835 x 929 x 745	+30°C/+90°C	230V/ 1ph/ 50Hz*	2	1500
MBUB3BM	2.071 €	1155 x 929 x 745	+30°C/+90°C	230V/ 1ph/ 50Hz*	3	2500
MBUB4BM	2.255 €	1475 x 929 x 745	+30°C/+90°C	400V/ 3ph/ 50Hz	4	3500

*Infrarrojos >3000W → 400V/3ph/50Hz · *Infrared >3000W → 400V/3ph/50Hz

Basic Buffet Baño María Ventilado · Basic Buffet Ventilated Bain Marie

Modelos · Models



MBUB3BMV



MBUB4BMV



MODELO Models	PRECIO Price	MEDIDAS Measures (mm)	TEMPERATURA Temperature (°C)	CLASE CLIMÁTICA Climatic Class (°C)	TENSIÓN -FRECUENCIA Electrical Data	MATERIAL Material	CUBETA Tank	POTENCIA Power (W)
MBUB3BMV	1.791 €	1155 x 929 x 745	+30°C/+90°C	4 / 38°C	230V/ 1ph/ 50Hz	AISI 304	3 GN	1040
MBUB4BMV	2.007 €	1475 x 929 x 745	+30°C/+90°C	4 / 38°C	230V/ 1ph/ 50Hz*	AISI 304	4 GN	2080

*Infrarrojos >3000W → 400V/3ph/50Hz · *Infrared >3000W → 400V/3ph/50Hz



MBUB4BMV



MBUB3BMV

Serie Basic Buffet Vitrocerámica · Basic Buffet Glass Ceramic Series

Modelos · Models



MBUB2VC



MBUB3VC



MBUB4VC



MODELO Models	PRECIO Price	MEDIDAS Measures (mm)	TEMPERATURA Temperature (°C)	TENSIÓN - FRECUENCIA Electrical Data	CUBETAS Tank	POTENCIA Power (W)
MBUB2VC	1.745 €	835 x 929 x 745	Max +90°C	230V/ 1ph/ 50Hz	—	900
MBUB3VC	1.970 €	1155 x 929 x 745	Max +90°C	230V/ 1ph/ 50Hz	—	1350
MBUB4VC	2.807 €	1475 x 929 x 745	Max +90°C	230V/ 1ph/ 50Hz*	—	1800

*Infrarrojos >3000W → 400V/3ph/50Hz · *Infrared >3000W → 400V/3ph/50Hz



MBUB4VC

Serie Basic Buffet Cuba Fría · Basic Buffet Cold Tank Series

Modelos · Models



MBUB2CF



MBUB3CF



MBUB4CF

Serie Basic Buffet Cuba Fría Ventilada · Basic Buffet Cold Tank Ventilated Series

Modelos · Models



MBUB3CFV



MBUB4CFV

Serie Basic Buffet Placa Fría · Basic Buffet Cold Plate Series

Modelos · Models



MBUB2PF



MBUB3PF



MBUB4PF



MBUB4CFV



MBUB3PF



MODELO Models	PRECIO Price	MEDIDAS Measures (mm)	TEMPERATURA Temperature (°C)	TENSIÓN -FRECUENCIA Electrical Data	CUBETAS Tank	POTENCIA Power (W)
MBUB2CF	2.062 €	835 x 929 x 745	+2°C/+10°C	230V/ 1ph/ 50Hz	2	223
MBUB3CF	2.441 €	1155 x 929 x 745	+2°C/+10°C	230V/ 1ph/ 50Hz	3	223
MBUB4CF	2.669 €	1475 x 929 x 745	+2°C/+10°C	230V/ 1ph/ 50Hz	4	223



MODELO Models	PRECIO Price	MEDIDAS Measures (mm)	TEMPERATURA Temperature (°C)	TENSIÓN -FRECUENCIA Electrical Data	CUBETAS Tank	POTENCIA Power (W)
MBUB3CFV	2.960 €	1155 x 929 x 745	+2°C/+10°C	230V/ 1ph/ 50Hz	3	637
MBUB4CFV	3.448 €	1475 x 929 x 745	+2°C/+10°C	230V/ 1ph/ 50Hz	4	637



MODELO Models	PRECIO Price	MEDIDAS Measures (mm)	TEMPERATURA Temperature (°C)	TENSIÓN -FRECUENCIA Electrical Data	CUBETAS Tank	POTENCIA Power (W)
MBUB2PF	1.716 €	835 x 929 x 745	-4°C/+4°C	230V/ 1ph/ 50Hz	223
MBUB3PF	1.860 €	1155 x 929 x 745	-4°C/+4°C	230V/ 1ph/ 50Hz	223
MBUB4PF	1.969 €	1475 x 929 x 745	-4°C/+4°C	230V/ 1ph/ 50Hz	223

MBUB4CF



Serie Basic Buffet Vitrina Baja · Low-profile open display case

Modelos · Models



MBUB3VAB



MBUB4VAB

Serie Basic Buffet Vitrina con Cortina · Display case with fitted night curtain

Modelos · Models



MBUB3VMC



MBUB4VMC

Serie Basic Buffet Vitrina con Vidrio Delantero · Display case front glass

Modelos · Models



MBUB3VAV



MBUB4VAV



MBUB4VAB

MODELO Models	PRECIO Price	MEDIDAS Measures (mm)	TEMPERATURA Temperature (°C)	TENSIÓN -FRECUENCIA Electrical Data	POTENCIA Power (W)
MBUB3VAB	3109 €	1155 x 1111 x 745	+4°C/+12°C	230V/ 1ph/ 50Hz	437
MMBUB4VAB	3406 €	1475 x 1111 x 745	+4°C/+12°C	230V/ 1ph/ 50Hz	437

MODELO Models	PRECIO Price	MEDIDAS Measures (mm)	TEMPERATURA Temperature (°C)	TENSIÓN -FRECUENCIA Electrical Data	POTENCIA Power (W)
MBUB3VMC	4386 €	1155 x 1546 x 745	+4°C/+12°C	230V/ 1ph/ 50Hz	1246
MBUB4VMC	4996 €	1475 x 1546 x 745	+4°C/+12°C	230V/ 1ph/ 50Hz	1646

MODELO Models	PRECIO Price	MEDIDAS Measures (mm)	TEMPERATURA Temperature (°C)	TENSIÓN -FRECUENCIA Electrical Data	POTENCIA Power (W)
MBUB3VAV	4723 €	1155 x 1546 x 745	+4°C/+12°C	230V/ 1ph/ 50Hz	804
MBUB4VAV	5597 €	1475 x 1546 x 745	+4°C/+12°C	230V/ 1ph/ 50Hz	1000



MBUB4VAV

Serie Basic Buffet Neutro · Basic Buffet Neutral Series

Modelos · Models



MBUB2NE



MBUB3NE



MBUB4NE



MBUBESQ



MODELO Models	PRECIO Price	MEDIDAS Measures (mm)	TEMPERATURA Temperature (°C)	TENSIÓN · FRECUENCIA Electrical Data	CUBETAS Tank	POTENCIA Power (W)
MBUB2NE	898 €	835 x 929 x 745	-----	230V/ 1ph/ 50Hz*	-----	-----
MBUB3NE	1.050 €	1155 x 929 x 745	-----	230V/ 1ph/ 50Hz*	-----	-----
MBUB4NE	1.128 €	1475 x 929 x 745	-----	230V/ 1ph/ 50Hz*	-----	-----
MBUBESQ	1.140 €	1060 x 929 x 1060	-----	-----	-----	-----

* Si lleva iluminación y/o infrarrojo.

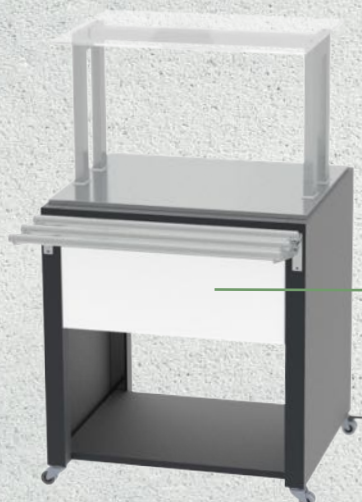

MBUB2NE

Decoración de serie



MBUB4NE

● Opcional decoración frontal completa

CHASIS

Colores estructura basic buffet

Puedes elegir entre 2 colores (blanco o gris antracita) para el color del chasis sin coste incluido. Chasis en acero inoxidable consultar.



BLANCO · WHITE



GRIS ANTRACITA · ANTHRACITE GREY



ACERO · STAINLESS STEEL

CHASSIS

Structure colours basic buffet

You can choose between 2 colours chassis (White and anthracite grey). Chassis in stainless steel consulting.

CORREBANDEJAS ABATIBLE · SLIDE RACKS

Nuevo correbandejas con alto diseño tecnológico
New racks slider with high technological design



CORREBANDEJAS ABATIBLE			
MODELO · Models	CBBU2	CBBU3	CBBU4
PRECIO · PRICE	216 €	228 €	239 €
MEDIDAS (mm)	820 x 317 x 145	1140 x 317 x 145	1460 x 317 x 145

ESTANTE INFERIOR · BOTTOM SHELF

Puede seleccionar el estante inferior del mismo color que la estructura.
You can select the bottom shelf in the same colour as the frame.



ESTANTE INFERIOR			
MODELO · Models	ESTBU2	ESTBU3	ESTBU4
PRECIO · PRICE	121 €	141 €	158 €
MEDIDAS (mm)	799 x 618 x 24	1119 x 618 x 24	1439 x 618 x 24

Incremento de Precio para el Cambio de Decoración Price Increase for Change of Decoration

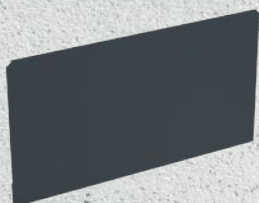

INCREMENTO DE PVP PARA LA DECORACIÓN LARGA			
MODELO - Models	2GN	3GN	4GN
PRECIO - PRICE	52 €	58 €	66 €
MEDIDAS (mm)	707 x 828 x 19	1027 x 828 x 19	1347 x 828 x 19

Solo se puede cambiar de decoración corta o media a larga, como se muestra en las siguientes imágenes.

It is only possible to change from short or medium to long decoration, as shown in the following pictures.

Decoración Corta · Short Decoration

Decoración Larga · Long Decoration



Decoración Media · Medium Decoration

Decoración Larga · Long Decoration



COLOR DECORACIÓN DECORATION COLOUR



ANNIVERSARY O1OAK

					
RAL 9016 Blanco White	RAL 9017 Negro Black	Wenge Wenge	Nogal Walnut	Luxe Aubergine	RAL 4007 Violeta Violet
					
RAL 3003 Granate Marron	RAL 3020 Rojo Red	Curry Curry	RAL 1001 Beige Beige	RAL 6002 Verde oscuro Dark green	RAL 1107060 Pistacho Pistachio
					
RAL 5015 Azul Blue	RAL 2108025 Celeste Sky Blue	Cuzco Cobre Cuzco Cuivre	Gris Metallo Gris Métal	IDA03RT	ANNIVERSARY O1OAK
					
ANNIVERSARY O2OAK	ANNIVERSARY O3OAK				

Otro color consultar precio
Other colour consult price

Puede existir variación entre el color de esta impresión y el color real
There may be variation between print colour and true colour

Composición Conjunto Pantallas · Composition Set Screens

Dependiendo de las necesidades se pueden hacer las siguientes combinaciones para la composición de un conjunto completo:
 Depending on the requirements, these can be made the following combinations for the composition of a complete set:

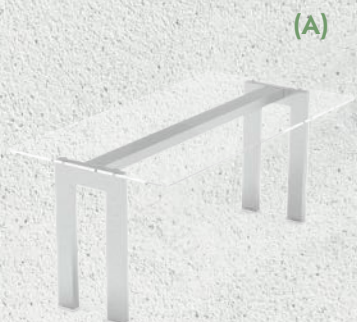

(A)

- A.**
*** Soporte 1 altura**
 - Soporte 1 altura: EEECU1
 - Pantalla ciega: EEPCU
 - Vidrio superior: EEVSU

- A.**
*** one height support**
 - Single height support: EEECU1
 - Screen: EEPCU
 - Glass top: EEVSU



(B)

- B.**
*** Soporte 1 altura**
 - Soporte 1 altura: EEECU1
 - Pantalla (ciega, iluminación, infrarrojos, iluminación+infrarrojos)
 - Vidrio superior: EEVSU
 - Vidrio frontal: EEVFU

- B.**
*** one height support**
 - Single height support: EEECU1
 - Screen (lighting+ infrared)
 - Glass top: EEVSU
 - Front glass: EEVFU



(C)

- C.**
*** Soporte 2 alturas**
 - Soporte 2 altura: EEECU2
 - Pantalla (2un) (ciega, iluminación, infrarrojos, iluminación+infrarrojos)
 - Vidrio superior: EEVSU
 - Estante cristal: EEVEU

- C.**
*** Double height support**
 - Double height support: EEECU2
 - Screen (2units) (lighting + infrared)
 - Glass top: EEVSU
 - Glass shelf: EEVEU

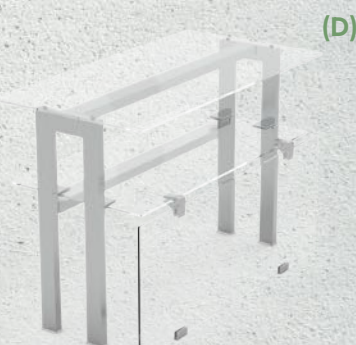

(D)

- D.**
*** Soporte 2 alturas + vidrio frontal**
 - Soporte 2 altura: EEECU2
 - Pantalla (2un) (ciega, iluminación, infrarrojos, iluminación+infrarrojos)
 - Vidrio superior: EEVSU
 - Estante cristal: EEVEU
 - Vidrio frontal: EEVFU

- D.**
*** Double height and front glass**
 - Double height support: EEECU2
 - Screen (2units) (lighting and infrared)
 - Top Glass: EEVSU
 - Glass shelf: EEVEU
 - Front glass: EEVFU



(E)

- E.**
*** Pantalla Nueva**
 - Con iluminación: EEEBIU

- E.**
*** New Display**
 - EEEBIU lighting



(F)

- F.**
*** Nueva estructura con vidrio superior y tabicas**
 - Con infrarrojos EEEBIRU
 - Con vidrio superior EEVSU
 - Con tabicas EEVTU

- F.**
*** New structure with top glass and dividers**
 - EEEBIRU infrared
 - EEVSU top glass
 - EEVTU dividers

Soportes para Pantallas · Screen Supports



MODELO · Models	EEECU1	EEECU2
PRECIO · PRICE	292 €	572 €
ALTURA · HEIGHT (mm)	1	2
MEDIDAS · MEASURES (mm)	260 x 30 x 476	260 x 30 x 766

Tipo de Pantallas · Type of Screens



(A) Pantalla Iluminación
Lighting Screen

(A) PANTALLA ILUMINACIÓN / LIGHTING SCREEN			
MODELO · Models	EEKIU750	EEKIU1125	EEKIU1500
PRECIO · PRICE	266 €	274 €	285 €
MEDIDAS · MEASURES (mm)	710 x 74 x 36	1030 x 74 x 36	1350 x 74 x 36
Para Módulos de: For Modules of:	2GN	3GN	4GN

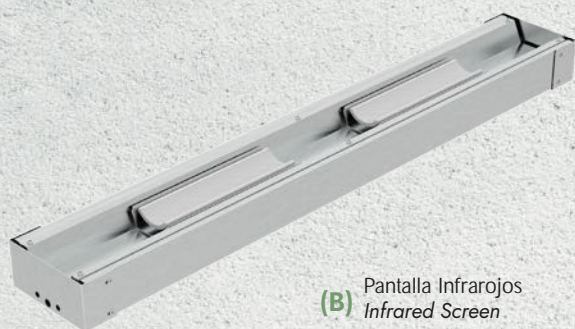

(B) Pantalla Infrarojos
Infrared Screen

(B) PANTALLA INFRAROJOS / INFRARED SCREEN			
MODELO · Models	EEKIRU750	EEKIRU1125	EEKIRU1500
PRECIO · PRICE	345 €	436 €	531 €
MEDIDAS · MEASURES (mm)	710 x 155 x 74	1030 x 155 x 74	1350 x 155 x 74
POTENCIA · POWER	500 W	1000 W	1500 W
Para Módulos de: For Modules of:	2GN	3GN	4GN



(C) Pantalla Iluminación más Infrarojos
Lighting and Infrared Screen

(C) PANTALLA ILUMINACIÓN MÁS INFRAROJOS / LIGHTING AND INFRARED SCREEN			
MODELO · Models	EEKIRLU750	EEKIRLU1125	EEKIRLU1500
PRECIO · PRICE	447 €	544 €	661 €
MEDIDAS · MEASURES (mm)	710 x 248 x 74	1030 x 248 x 74	1350 x 248 x 74
POTENCIA · POWER	500 W	1000 W	1500 W
Para Módulos de: For Modules of:	2GN	3GN	4GN



(D) Estructura Sólida
Solid Structure

(D) ESTRUCTURA SÓLIDA · SOLID STRUCTURE			
ILUMINACIÓN	EEEBIU750	EEEBIU1125	EEEBIU1500
PRECIO · PRICE	281 €	308 €	339 €
INFRAROJOS	EEEBIRU750	EEEBIRU1125	EEEBIRU1500
POTENCIA	500 W	1000 W	1500 W
PRECIO · PRICE	360 €	470 €	585 €
ILUMINACIÓN MÁS INFRAROJOS	EEEBIRLU750	EEEBIRLU1125	EEEBIRLU1500
POTENCIA	500 W	1000 W	1500 W
PRECIO · PRICE	462 €	578 €	715 €
MEDIDAS-MEASURES (mm)	772 x 151 x 475	1092 x 151 x 475	1412 x 151 x 475
PARA MÓDULOS DE	2GN	3GN	4GN



(E) Vidrio Superior
Glass Top

(E) VIDRIO SUPERIOR/GLASS TOP			
MODELO · Models	EEVSU750	EEVSU1125	EEVSU1500
PRECIO · PRICE	104 €	112 €	127 €
MEDIDAS-MEASURES (mm)	790 x 590 x 8	1110 x 590 x 8	1430 x 590 x 8
Para Módulos de: For Modules of:	2GN	3GN	4GN

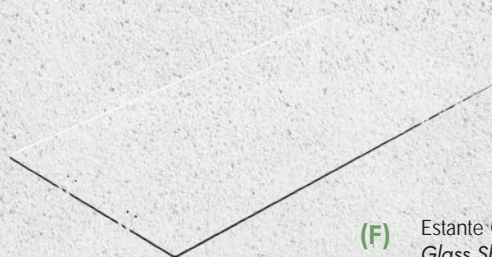

(F) Estante Cristal
Glass Shelf

(F) ESTANTE CRISTAL/ GLASS SHELF			
MODELO · Models	EEVEU750	EEVEU1125	EEVEU1500
PRECIO · PRICE	85 €	97 €	114 €
MEDIDAS-MEASURES (mm)	705 x 470 x 8	1025 x 470 x 8	1345 x 470 x 8
Para Módulos de: For Modules of:	2GN	3GN	4GN

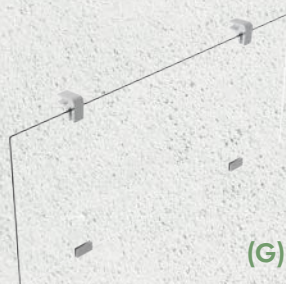

(G) Vidrio Frontal
Front Glass

(G) VIDRIO FRONTAL / FRONT GLASS			
MODELO · Models	EEVFU750	EEVFU1125	EEVFU1500
PRECIO · PRICE	210 €	224 €	236 €
MEDIDAS-MEASURES (mm)	790 x 460 x 8	1110 x 460 x 8	1430 x 460 x 8
Para Módulos de: For Modules of:	2GN	3GN	4GN



(H) Tabicas
Tabicas

(H) TÁBICAS · TÁBICAS			
	EEVSTU750	EEVSTU1125	EEVSTU1500
Para Módulos de: For Modules of:	2GN (750)	3GN (1125)	4GN (1500)
PRECIO · PRICE	164 €	172 €	179 €
MEDIDAS-MEASURES (mm)	790 x 100 x 8	1110 x 100 x 8	1430 x 100 x 8





STIPRO buffet

MB100CF3



Una experiencia
gast/ronómica
A gastronomic experience





CARÁCTERÍSTICAS GENERALES

GENERAL CHARACTERISTICS



- Módulos estándar con encimera y decoraciones en color blanco.
- Decoración disponible en varios colores y varios de acabados en madera.
- Encimeras de cuarzo con frontal de 90mm. Disponible en otros colores.
- Ruedas de serie para su desplazamiento.
- Patas regulables en altura para fijar y estabilizar la posición del mueble.
- Pueden suministrarse módulos independientes o configurar lineales.
- Kit de unión para cuando se suministre un lineal de varios módulos.
- Costados y rodapiés extraíbles para fácil acceso al interior del mueble.
- Capacidades disponibles en 2GN, 3GN, 4GN y 5GN con amplia variedad de drop in.
- Fondos disponibles de 830mm y 1000mm.
- Cajón de platos iluminado disponible en fondo 1000mm, excepto en cuba fría ventilada y en vitrinas. En fondo 830mm solo disponible en placa fría, vitrocerámica y neutro.
- Pantallas disponibles: iluminación, infrarrojos e iluminación más infrarrojos.
- Drop in centrado en el módulo de fondo 830mm y desplazado hacia el fondo en el de 1000mm, dejando así en la parte delantera un espacio disponible de 252mm que hace la función de correbandejas.

- Standard modules with countertop and decorations in white.
- Decoration available in various colors and several wood finishes.
- Quartz countertops with 90mm front. Available in other colors.
- Standard wheels for movement.
- Height-adjustable legs to fix and stabilize the position of the furniture.
- Stand-alone modules or linear configurations can be supplied.
- Joining kit for when a linear of several modules is supplied.
- Removable sides and skirting boards for easy access to the interior of the furniture.
- Capacities available in 2GN, 3GN, 4GN and 5GN with a wide variety of drop in.
- Available bottoms of 830mm and 1000mm.
- Illuminated plate drawer available on 1000mm background, except in ventilated cold tank and in showcases. In bottom 830mm only available in cold, glass-ceramic and neutral plate.
- Available displays: illumination, infrared and illumination plus infrared.
- Drop-in centered in the 830mm bottom module and moved towards the bottom in the 1000mm, thus leaving in the front an available space of 252mm that makes the function of tray runners.



MÓDULO FONDO 830 mm
MODULE DEPTH 830mm

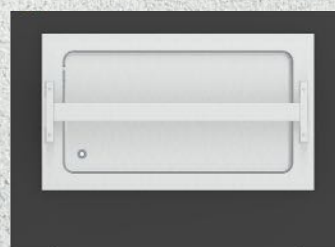

MÓDULO FONDO 1000 mm
MODULE DEPTH 1000 mm

CONFIGURACIÓN LINEAL BUFFET

LINEAR BUFFET CONFIGURATION



EJEMPLO DE LINEAL BUFFET · LINEAR BUFFET EXAMPLE

Los lineales se configuran de izquierda a derecha y se configuran los módulos por independiente.

The linear ones are configured from left to right and the modules are configured independently.

1. MB100TL30

- Encimera: Negra
- Decoraciones: Anniversary 030AK

2. MB100NE3

- Encimera: Negra
- Decoraciones: Anniversary 030AK
- Soporte pantalla: EEECU2 (2 alturas)
- Pantallas: EEPCU1125 (ciega), EEKIU1125 (iluminación)
- Vidrio superior: EEVSU1125
- Estante cristal: EEVEU1125
- Vidrio frontal: EEVFU1125

3. MB100BM3

- Encimera: Negra
- Decoraciones: Anniversary 030AK
- Soporte pantalla: EEECU1 (1 altura)
- Pantallas: EEKIRU1125 (infrarrojos)
- Vidrio superior: EEVSU1125
- Vidrio frontal: EEVFU1125

4. MB100PF3

- Encimera: Negra
- Decoraciones: Anniversary 030AK
- Soporte pantalla: EEECU1 (1 altura)
- Pantallas: EEKIU1125 (iluminación)
- Vidrio superior: EEVSU1125

5. MB100VAV3

- Encimera: Negra
- Decoraciones: Anniversary 030AK

6. MB100TL100

- Encimera: Negra
- Decoraciones: Anniversary 030AK

1. MB100TL30

- Worktop: black
- Decorations: Anniversary 030AK

2. MB100NE3

- Worktop: black
- Decorations: Anniversary 030AK
- Screen support: EEECU2 (2 heights)
- Screens: EEPCU1125 (standard), EEKIU1125 (lighting)
- Glass top: EEVSU1125
- Glass shelf: EEVEU1125
- Front glass: EEVFU1125

3. MB100BM3

- Worktop: black
- Decorations: Anniversary 030AK
- Screen support: EEECU1 (1 height)
- Screens: EEKIRU1125 (infrared)
- Glass top: EEVSU1125
- Front glass: EEVFU1125

4. MB100PF3

- Worktop: black
- Decorations: Anniversary 030AK
- Screen support: EEECU1 (1 height)
- Screen: EEKIU1125 (lighting)
- Front glass: EEVSU1125

5. MB100VAV3

- Worktop: black
- Decorations: Anniversary 030AK

6. MB100TL100

- Worktop: black
- Decorations: Anniversary 030AK

Serie Gastrobuffet Baño María · Series Gastrobuffet Bain Marie

Modelos · Models



MB80BM2



MB80BM3



MB80BM4



MB80BM5



MB100BM2

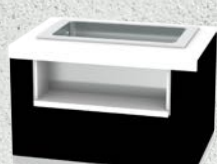

MB100BM3



MB100BM4



MB100BM5

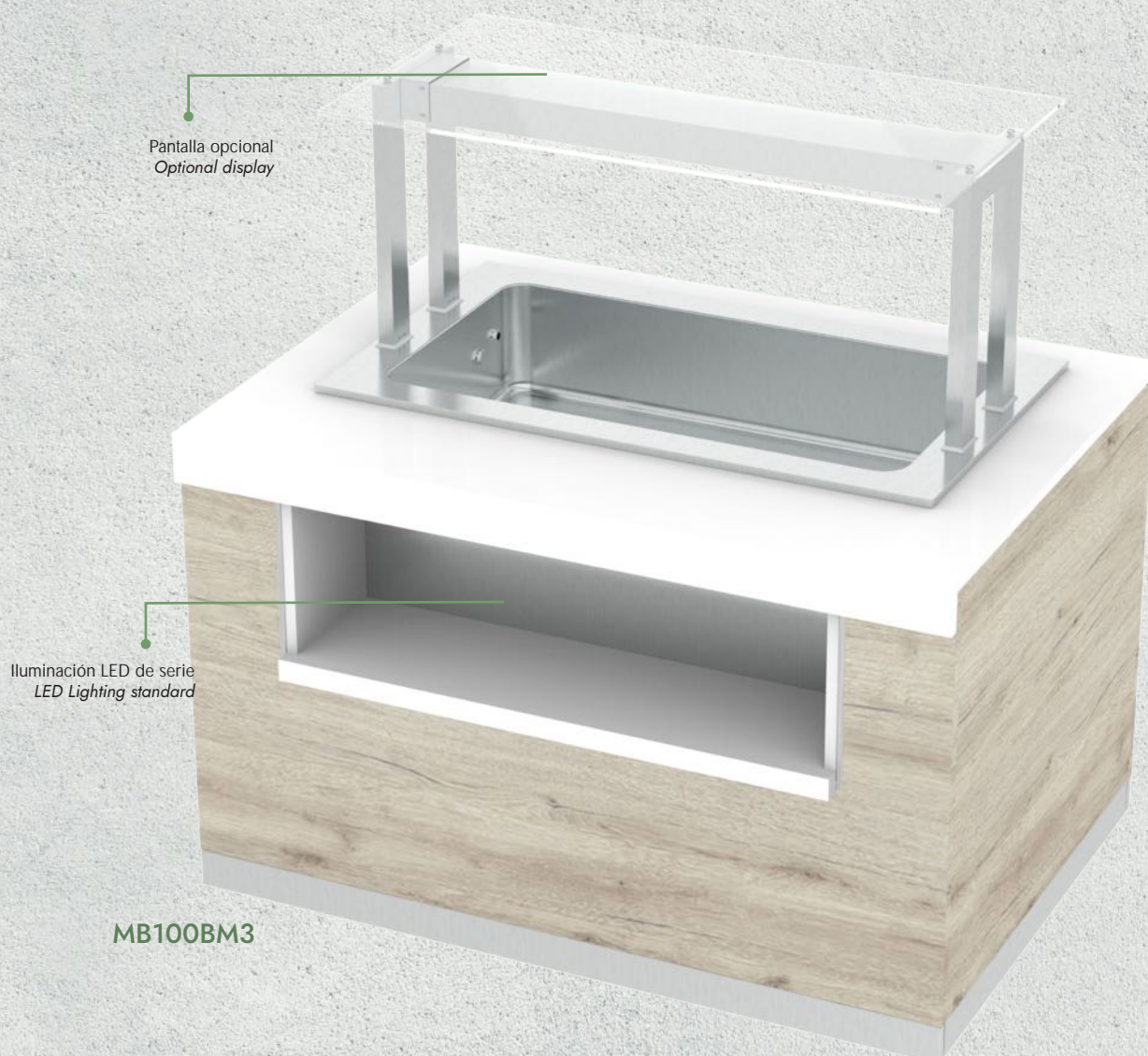



MODELO Models	PRECIO Price	MEDIDAS Measures (mm)	TEMPERATURA Temperature (°C)	TENSION -FRECUENCIA Electrical Data	ESTANTE PARA PLATOS Plates Shelf	CUBETAS Tank	POTENCIA Power (W)
MB80BM2	3.544 €	1100 x 830 x 900	+30°C/+90°C	230V/ 1ph / 50Hz*	-----	2	1500
MB80BM3	4.211 €	1400 x 830 x 900	+30°C/+90°C	230V/ 1ph / 50Hz*	-----	3	2500
MB80BM4	4.985 €	1700 x 830 x 900	+30°C/+90°C	400V/ 3ph/ 50Hz	-----	4	3500
MB80BM5	5.705 €	2025 x 830 x 900	+30°C/+90°C	400V/ 3ph/ 50Hz	-----	5	4500
MB100BM2	3.667 €	1100 x 1000 x 900	+30°C/+90°C	230V/ 1ph / 50Hz*	1	2	1500
MB100BM3	4.306 €	1400 x 1000 x 900	+30°C/+90°C	230V/ 1ph / 50Hz*	1	3	2500
MB100BM4	5.098 €	1700 x 1000 x 900	+30°C/+90°C	400V/ 3ph/ 50Hz	1	4	3500
MB100BM5	5.940 €	2025 x 1000 x 900	+30°C/+90°C	400V/ 3ph/ 50Hz	1	5	4500

Encimera de serie blanco. Incremento PVP por cambio de encimera [Consultar]. *Infrarrojos >3000W → 400V/3ph/50Hz · *Infrared >3000W → 400V/3ph/50Hz
 White standar top. To change the top increase price [To consult].

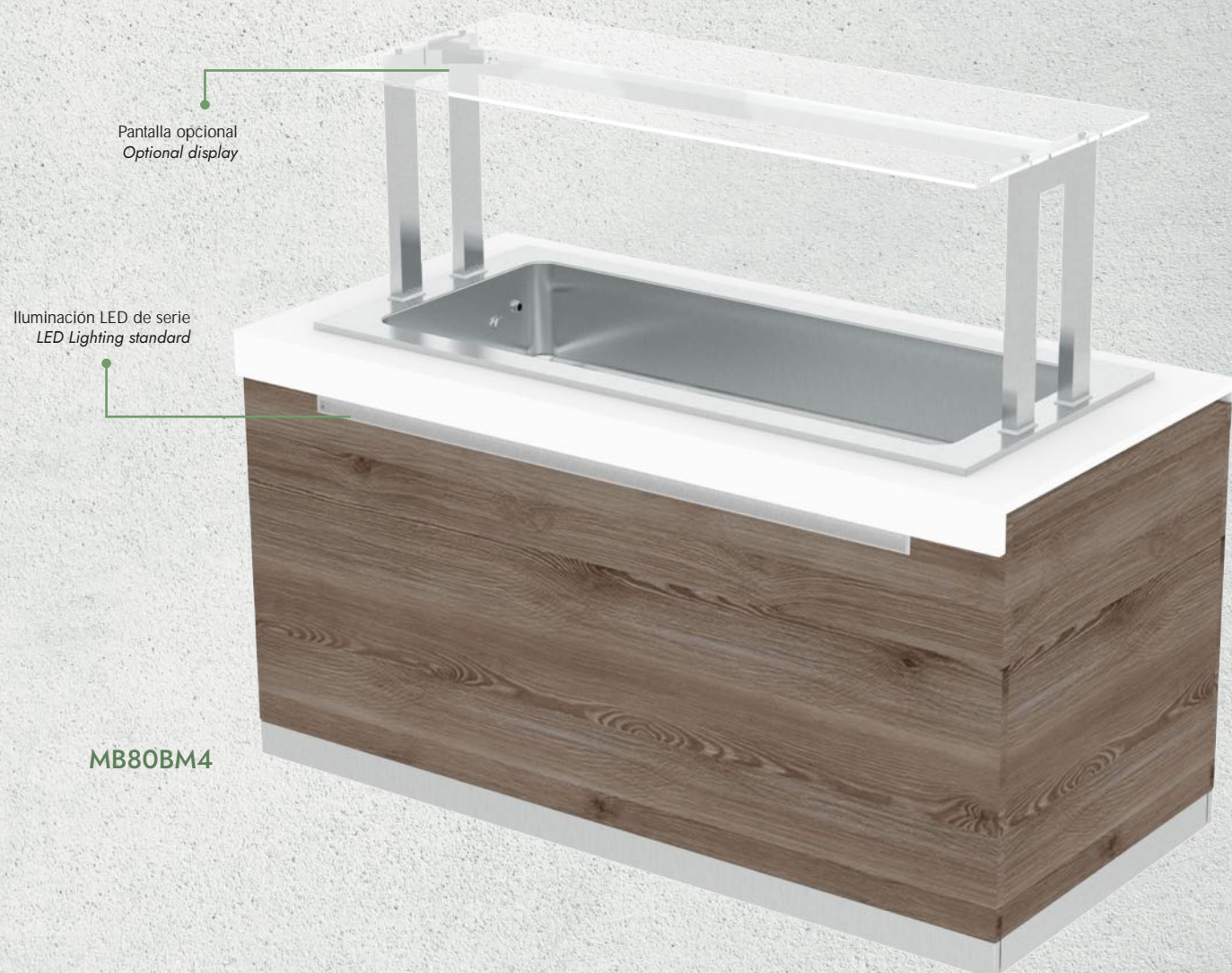

MB80BM4

Serie Gastrobuffet Baño María Ventilado Series Gastrobuffet Bain Marie ventilated Modelos · Models



MB80BMV3
Baño María Ventilado
Bain Marie Ventilated



MB80BMV4
Baño María Ventilado
Bain Marie Ventilated



MB100BMV3
Baño María Ventilado
Bain Marie Ventilated



MB100BMV4
Baño María Ventilado
Bain Marie Ventilated



Pantalla opcional
Lighting optional

Iluminación LED de serie
LED Lighting standard

MB80BMV3
Vista trasera
Back view



MODELO Models	PRECIO Price	MEDIDAS Measures (mm)	TEMPERATURA Temperature (°C)	TENSIÓN - FRECUENCIA Electrical Data	CUBETAS Tank	ESTANTE PARA PLATOS Plates Shelf	POTENCIA Power (W)	POTENCIA FRIG Cooling Capacity (W A · 10°C)
MB80BMV3	3.397 €	1400 x 830 x 900	+30°C/+90°C	230V/ 1ph / 50Hz*	3	-----	1040	-----
MB80BMV4	3.975 €	1700 x 830 x 900	+30°C/+90°C	230V/ 1ph / 50Hz*	4	-----	2080	-----
MB100BMV3	3.484 €	1400 x 1000 x 900	+30°C/+90°C	230V/ 1ph / 50Hz*	3	1	1040	-----
MB100BMV4	4.024 €	1700 x 1000 x 900	+30°C/+90°C	230V/ 1ph / 50Hz*	4	1	2080	-----

Encimera de serie blanco. Incremento PVP por cambio de encimera [Consultar]. *Infrarrojos >3000W → 400V/3ph/50Hz · *Infrared >3000W → 400V/3ph/50Hz
 White standar top. To change the top increase price [To consult].

Iluminación LED de serie
LED Lighting standard

Pantalla opcional
Optional display

MB100BMV4

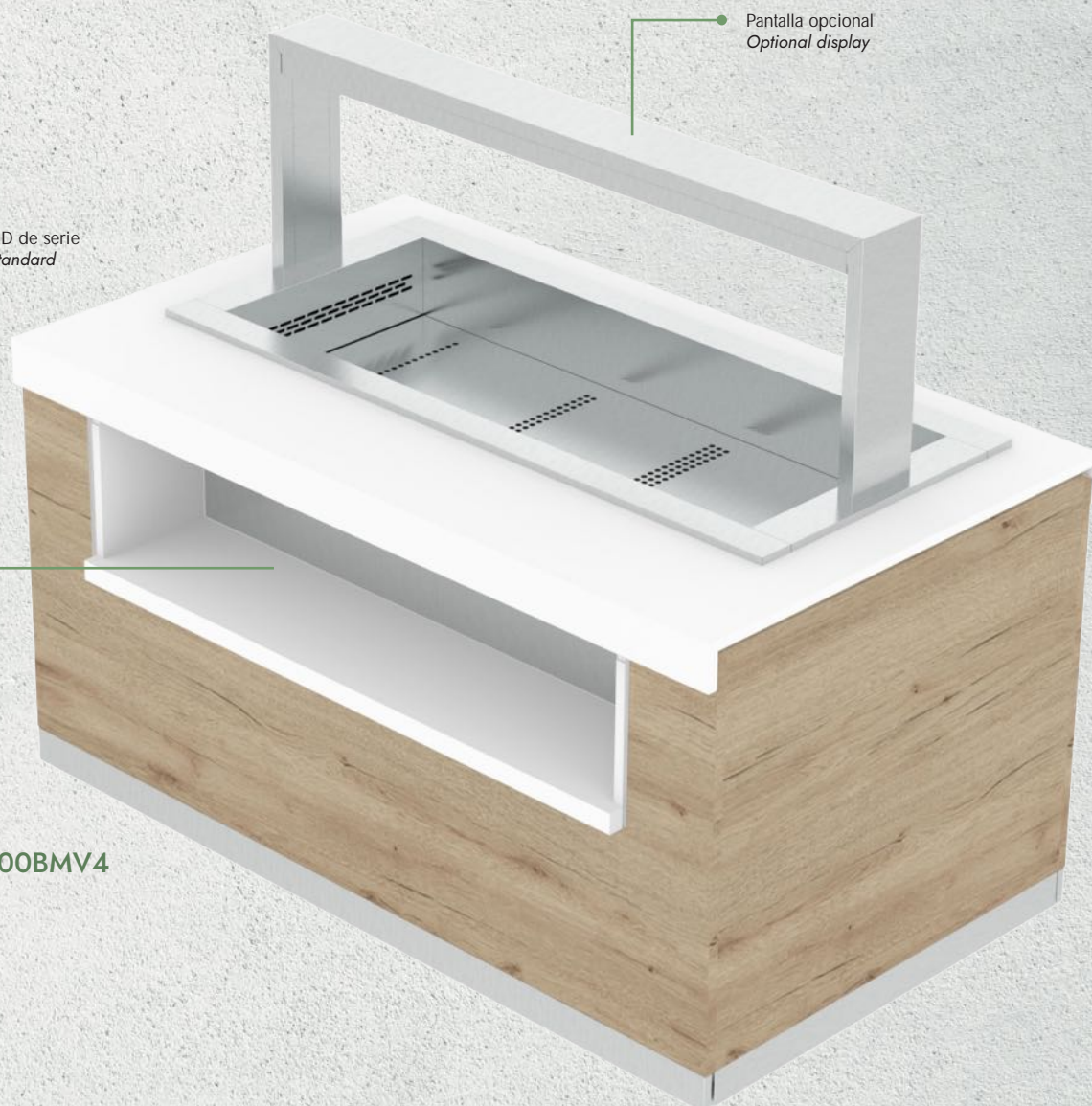

Serie Gastrobuffet Vitrocerámica · Series Glass-ceramic gastrobuffet

Modelos · Models

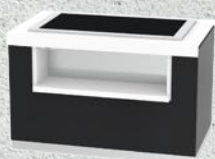

MB80VC3



MB80VC4



MB100VC3



MB100VC4

Pantalla opcional
Optional display



Iluminación LED de serie
LED Lighting standard

MB100VC4



MODELO Models	PRECIO Price	MEDIDAS Measures (mm)	TEMPERATURA Temperature (°C)	TENSIÓN · FRECUENCIA Electrical Data	ESTANTE PARA PLATOS Plates Shelf	POTENCIA Power (W)
MB80VC3	5.017 €	1400 x 830 x 900	Max. +130°C	230V/ 1ph / 50Hz*	1	1369
MB80VC4	6.428 €	1700 x 830 x 900	Max. +130°C	230V/ 1ph / 50Hz*	1	1825
MB100VC3	5.063 €	1400 x 1000 x 900	Max. +130°C	230V/ 1ph / 50Hz*	1	1369
MB100VC4	6.450 €	1700 x 1000 x 900	Max. +130°C	230V/ 1ph / 50Hz*	1	1825

Encimera de serie blanco. Incremento PVP por cambio de encimera [Consultar]. *Infrarrojos >3000W → 400V/3ph/50Hz · *Infrared >3000W → 400V/3ph/50Hz
 White standar top. To change the top increase price [To consult].



MB100VC3

Vista trasera
Back view

Serie Gastrobuffet Cuba Fría · Series Gastrobuffet Cold Tank
Modelos · Models



MB80CF2



MB80CF3



MB80CF4



MB80CF5



MB100CF2



MB100CF3



MB100CF4



MB100CF5



MB80CH4
 Cuba para helados
Ice cream tank



MB100CH4
 Cuba para helados
Ice cream tank

Pantalla opcional
 Optional display

Iluminación LED de serie
 LED Lighting standard



MB100CF3



MODELO Models	PRECIO Price	MEDIDAS Measures (mm)	TEMPERATURA Temperature (°C)	TENSIÓN - FRECUENCIA Electrical Data	CUBETAS Tank	ESTANTE PARA PLATOS Plates Shelf	POTENCIA Power (W)	POTENCIA FRIG Cooling Capacity (W A · 10°C)
MB80CF2	3.554 €	1100 x 830 x 900	+2°C/+10°C	230V/ 1ph/ 50Hz	2	-----	230	370
MB80CF3	4.030 €	1400 x 830 x 900	+2°C/+10°C	230V/ 1ph/ 50Hz	3	-----	233	370
MB80CF4	4.712 €	1700 x 830 x 900	+2°C/+10°C	230V/ 1ph/ 50Hz	4	-----	236	370
MB80CF5	5.129 €	2025 x 830 x 900	+2°C/+10°C	230V/ 1ph/ 50Hz	5	-----	396	687
MB100CF2	3.599 €	1100 x 1000 x 900	+2°C/+10°C	230V/ 1ph/ 50Hz	2	1	230	370
MB100CF3	4.119 €	1400 x 1000 x 900	+2°C/+10°C	230V/ 1ph/ 50Hz	3	1	233	370
MB100CF4	4.840 €	1700 x 1000 x 900	+2°C/+10°C	230V/ 1ph/ 50Hz	4	1	236	370
MB100CF5	5.225 €	2025 x 1000 x 900	+2°C/+10°C	230V/ 1ph/ 50Hz	5	1	396	687
MB80CH4	3.642 €	1100 x 830 x 900	-12°C/-18°C	230V/ 1ph/ 50Hz	4	-----	322	306
MB100CH4	3.687 €	1100 x 1000 x 900	-12°C/-18°C	230V/ 1ph/ 50Hz	4	1	322	306

REFRIGERANTE · REFRIGERANT R290

Encimera de serie blanco. Incremento PVP por cambio de encimera [Consultar].

White standar top. To change the top increase price [To consult].

Pantalla opcional
Optional display

Iluminación LED de serie
LED Lighting standard

MB100CF3

Vista trasera
Back view



Serie Gastrobuffet Cuba Fría Ventilada ·
Series Gastrobuffet cold tank ventilated
Modelos · Models



MB80CFV3



MB80CFV4



MB100CFV3



MB100CFV4

Pantalla opcional
Optional display

Iluminación LED de serie
LED Lighting standard

MB80CFV3

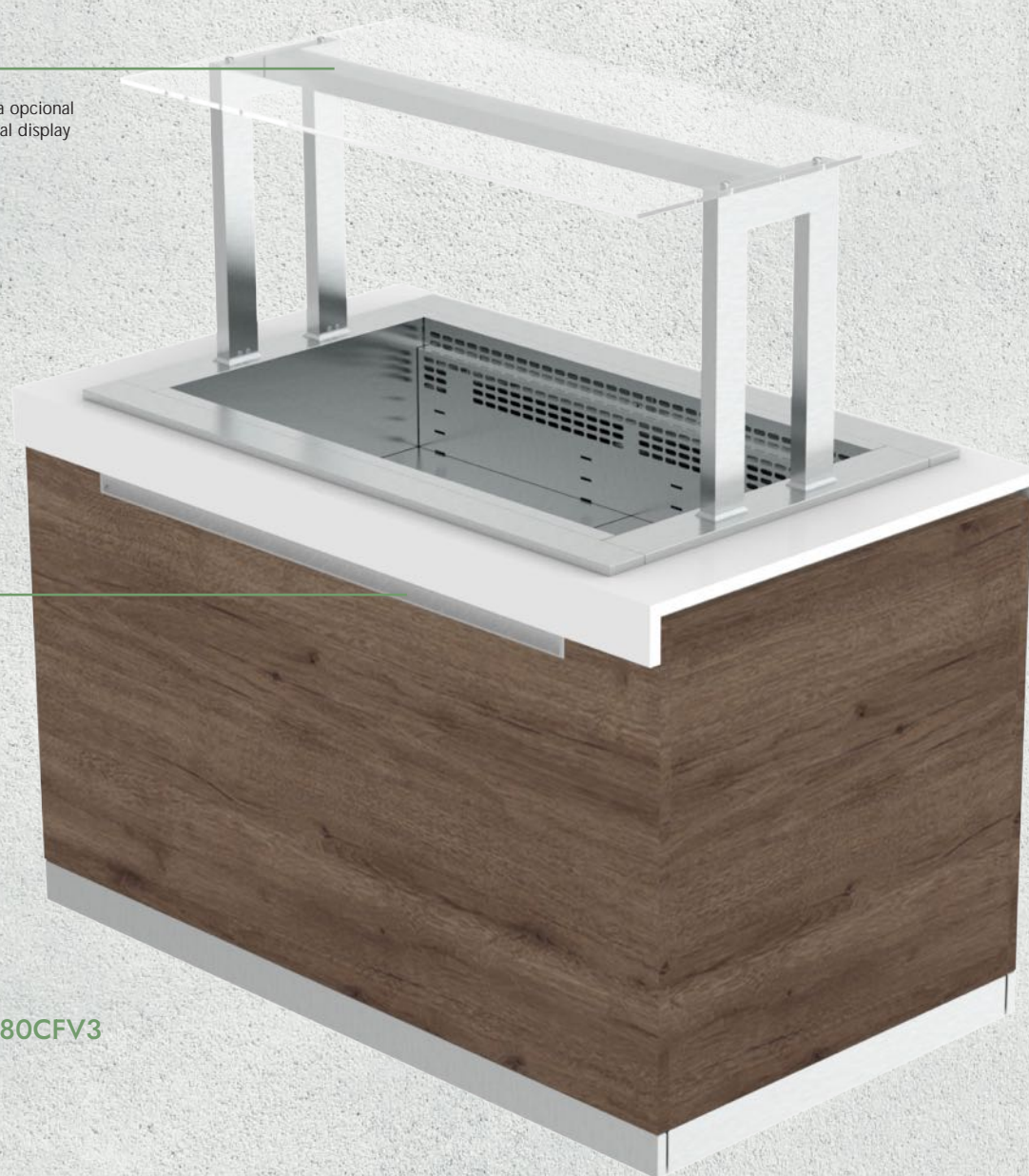



MODELO Models	PRECIO Price	MEDIDAS Measures (mm)	TEMPERATURA Temperature (°C)	TENSIÓN - FRECUENCIA Electrical Data	CUBETAS Tank	ESTANTE PARA PLATOS Plates Shelf	POTENCIA Power (W)	POTENCIA FRIG Cooling Capacity (W A · 10°C)
MB80CFV3	4.204 €	1400 x 830 x 900	+2°C/+10°C	230V/ 1ph/ 50Hz	3	-----	897	687
MB80CFV4	4.746 €	1700 x 830 x 900	+2°C/+10°C	230V/ 1ph/ 50Hz	4	-----	900	687
MB100CFV3	4.247 €	1400 x 1000 x 900	+2°C/+10°C	230V/ 1ph/ 50Hz	3	-----	897	687
MB100CFV4	4.790 €	1700 x 1000 x 900	+2°C/+10°C	230V/ 1ph/ 50Hz	4	-----	900	687

CUBA FRÍA: REFRIGERANTE R290 · COLD TANK: REFRIGERANT R290

Encimera de serie blanco. Incremento PVP por cambio de encimera [Consultar].

White standar top. To change the top increase price [To consult].

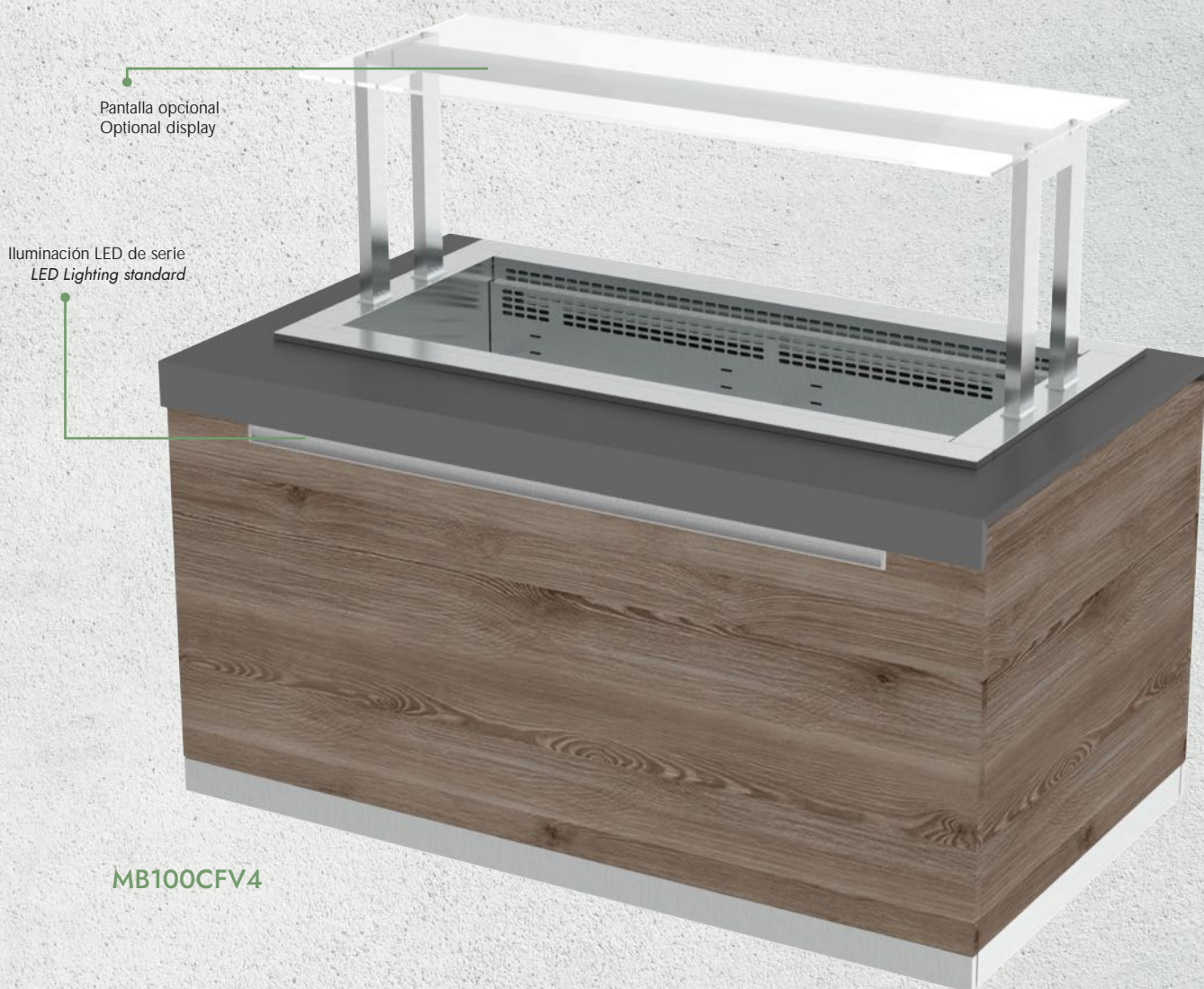

Pantalla opcional
Optional display

Iluminación LED de serie
LED Lighting standard

MB100CFV4

Serie Gastrobuffet Placa Fría · Series Gastrobuffet cold plate

Modelos · Models



MB80PF3



MB80PF4



MB80PF5



MB100PF3



MB100PF4



MB100PF5

Estructura opcional
Optional structure

Iluminación LED de serie
LED Lighting standard

MB80PF4

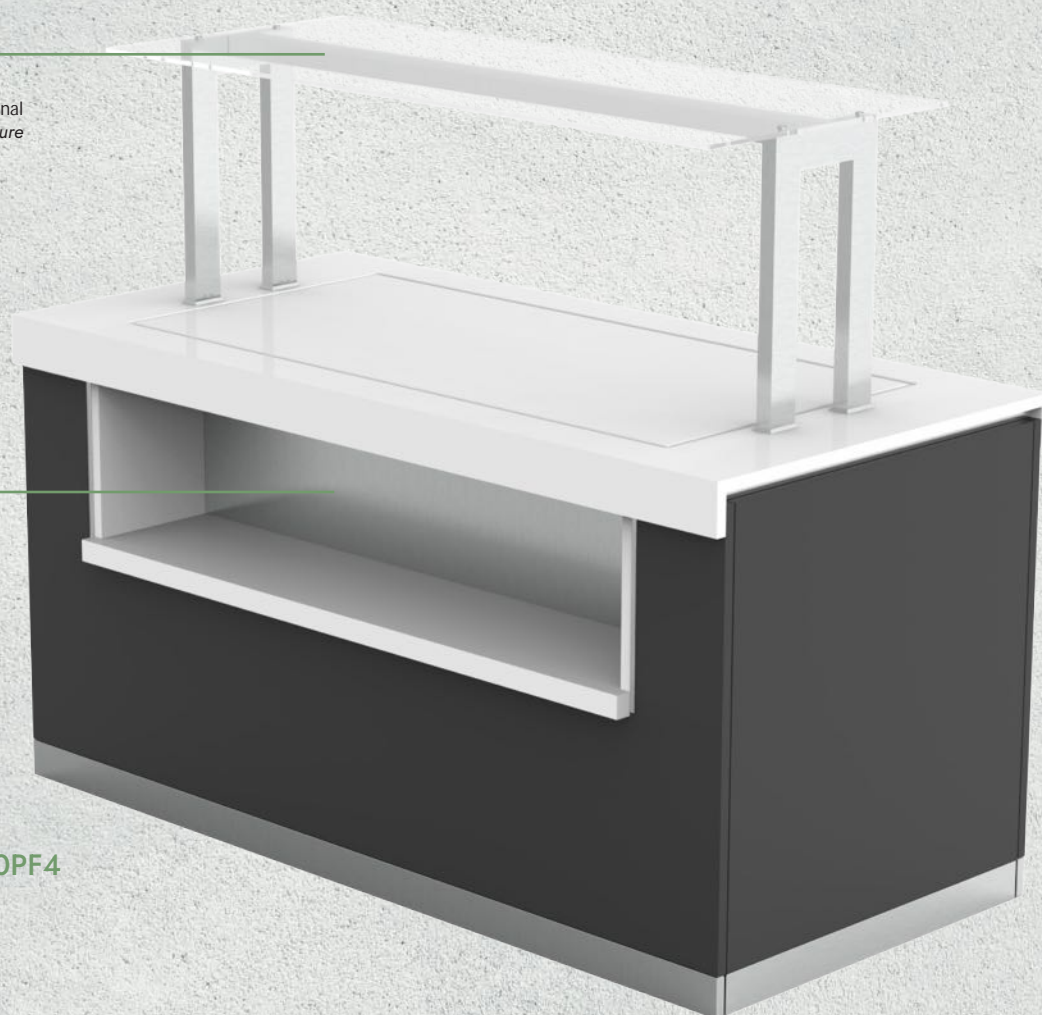



MODELO Models	PRECIO Price	MEDIDAS Measures (mm)	TEMPERATURA Temperature (°C)	TENSIÓN -FRECUENCIA Electrical Data	ESTANTE PARA PLATOS Plates Shelf	POTENCIA Power (W)	POTENCIA FRIG Cooling Capacity (W A · 10°C)
MB80PF3	3.864 €	1400 x 830 x 900	-4°C/+4°C	230V/ 1ph/ 50Hz	1	187	370
MB80PF4	4.251 €	1700 x 830 x 900	-4°C/+4°C	230V/ 1ph/ 50Hz	1	190	370
MB80PF5	4.828 €	2025 x 830 x 900	-4°C/+4°C	230V/ 1ph/ 50Hz	1	350	687
MB100PF3	3.873 €	1400 x 1000 x 900	-4°C/+4°C	230V/ 1ph/ 50Hz	1	187	370
MB100PF4	4.449 €	1700 x 1000 x 900	-4°C/+4°C	230V/ 1ph/ 50Hz	1	190	370
MB100PF5	5.384 €	2025 x 1000 x 900	-4°C/+4°C	230V/ 1ph/ 50Hz	1	350	687

REFRIGERANTE · REFRIGERANT R290

Encimera de serie blanco. Incremento PVP por cambio de encimera [Consultar].

White standar top. To change the top increase price [To consult].



MB100PF3
Vista trasera
Back view

Serie Vitrina Abierta Baja · Series Low-profile open display case
Modelos · Models



MB80VAB3



MB80VAB4



MB100VAB3



MB100VAB4

Iluminación LED de serie
LED Lighting standard



MB100VAB4



MODELO Models	PRECIO Price	MEDIDAS Measures (mm)	TEMPERATURA Temperature (°C)	TENSIÓN - FRECUENCIA Electrical Data	CUBETAS Tank	ESTANTE PARA PLATOS Plates Shelf	POTENCIA Power (W)	POTENCIA FRIG Cooling Capacity (W A · 10°C)
MB80VAB3	5.075 €	1400 x 830 x 1200	+2°C/+10°C	230V/ 1ph/ 50Hz	3	-----	417	687
MB80VAB4	5.639 €	1700 x 830 x 1200	+2°C/+10°C	230V/ 1ph/ 50Hz	4	-----	512	687
MB100VAB3	5.118 €	1400 x 1000 x 1200	+2°C/+10°C	230V/ 1ph/ 50Hz	3	-----	417	687
MB100VAB4	5.684 €	1700 x 1000 x 1200	+2°C/+10°C	230V/ 1ph/ 50Hz	4	-----	512	687

REFRIGERANTE · REFRIGERANT R290

Encimera de serie blanco. Incremento PVP por cambio de encimera [Consultar]. *White standar top. To change the top increase price [To consult].*

*En estos modelos no es posible colocar estructura para vidrio/pantalla superior.



Iluminación LED de serie
LED Lighting standard

MB80VAB3
Vista trasera
Back view

Serie Vitrinas Gastrobuffet con Cortina
Series Gastrobuffet Air Curtain Display Case
Modelos · Models



MB80VMC3



MB80VMC4



MB100VMC3



MB100VMC4

Illuminación LED de serie
LED Lighting standard



MB100VMC3



MODELO Models	PRECIO Price	MEDIDAS Measures (mm)	TEMPERATURA Temperature (°C)	TENSIÓN · FRECUENCIA Electrical Data	CUBETAS Tank	ESTANTE PARA PLATOS Plates Shelf	POTENCIA Power (W)	POTENCIA FRIG Cooling Capacity (W A · 10°C)
MB80VMC3	6.418 €	1400 x 830 x 1750	+4°C/+12°C	230V/ 1ph/ 50Hz	3	-----	1246	1296
MB80VMC4	7.438 €	1700 x 830 x 1750	+4°C/+12°C	230V/ 1ph/ 50Hz	4	-----	1646	1805
MB100VMC3	6.452 €	1400 x 1000 x 1750	+4°C/+12°C	230V/ 1ph/ 50Hz	3	-----	1246	1296
MB100VMC4	7.487 €	1700 x 1000 x 1750	+4°C/+12°C	230V/ 1ph/ 50Hz	4	-----	1646	1805

REFRIGERANTE · REFRIGERANT R290

Encimera de serie blanco. Incremento PVP por cambio de encimera [Consultar]. *White standar top. To change the top increase price [To consult].*

*En estos modelos no es posible colocar estructura para vidrio/pantalla superior.

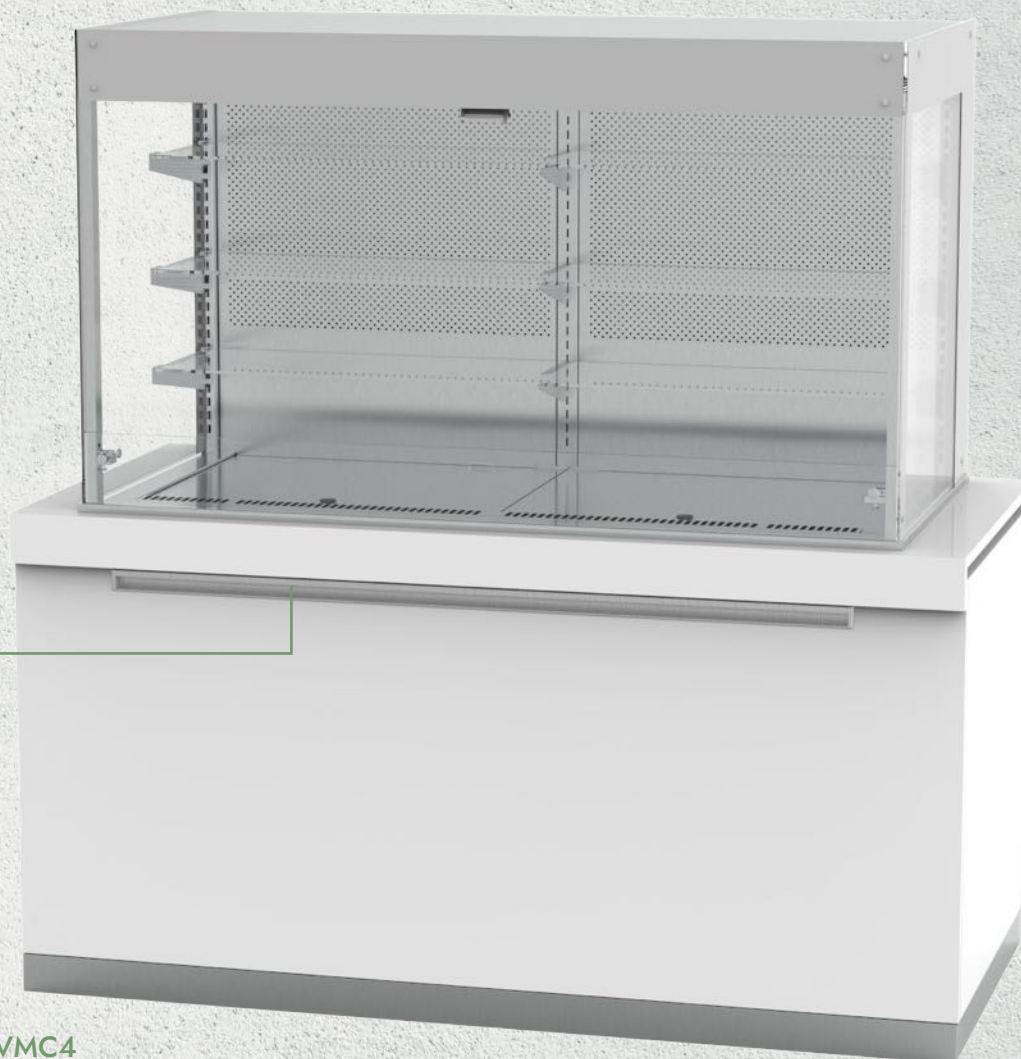

Iluminación LED de serie
LED Lighting standard

MB80VMC4

Serie Vitrinas Gastrobuffet con Vidrio Delantero Abatible
Series Gastrobuffet Hinged doors & front Glass
Modelos · Models



MB80VAV3



MB80VAV4



MB100VAV3



MB100VAV4

Iluminación LED de serie
LED Lighting standard

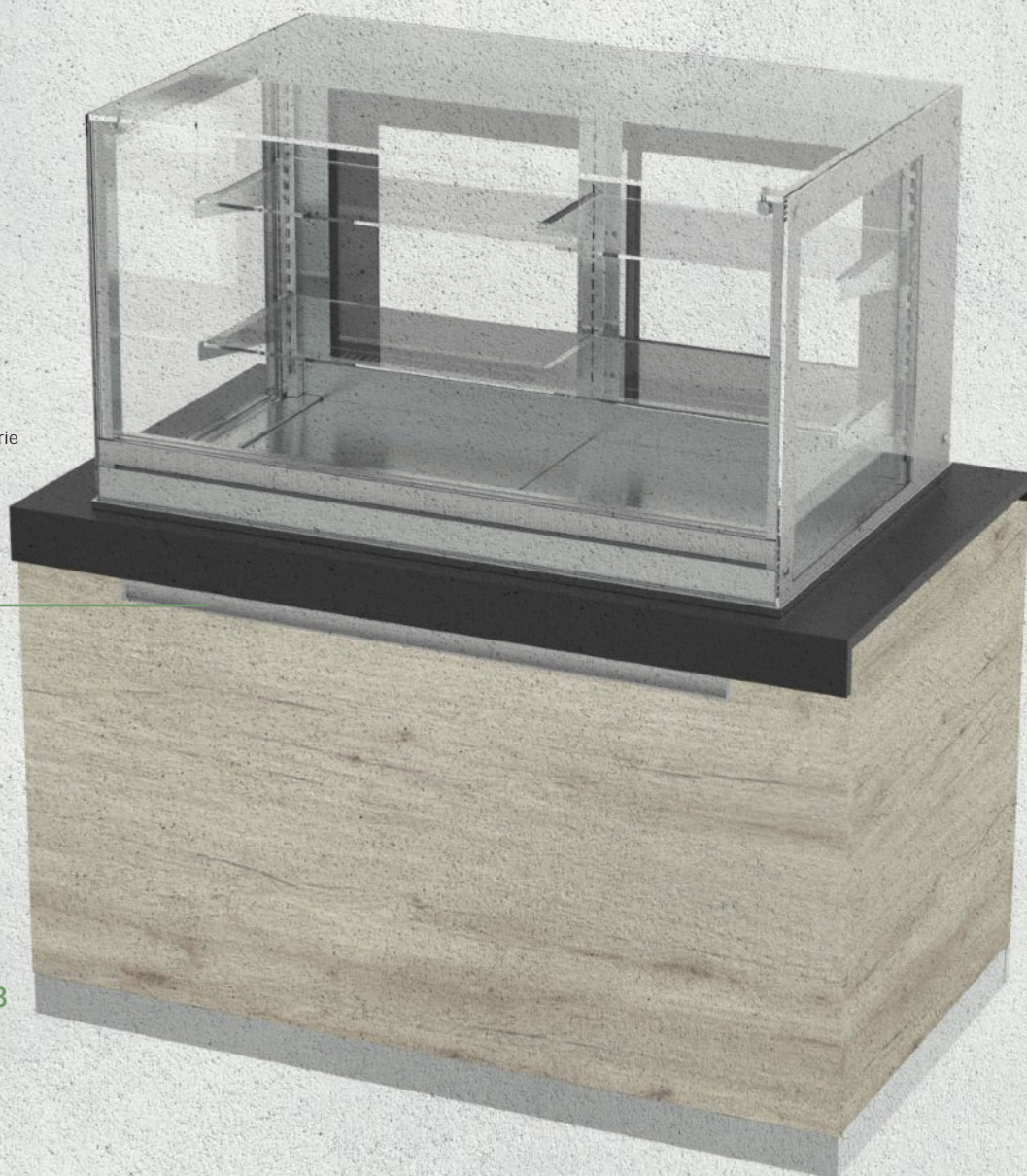

MB80VAV3



MODELO Models	PRECIO Price	MEDIDAS Measures (mm)	TEMPERATURA Temperature (°C)	TENSIÓN · FRECUENCIA Electrical Data	CUBETAS Tank	ESTANTE PARA PLATOS Plates Shelf	POTENCIA Power (W)	POTENCIA FRIG Cooling Capacity (W A · 10°C)
MB80VAV3	6.469 €	1400 x 830 x 1428	+4°C/+12°C	230V/ 1ph/ 50Hz	3	-----	804	951
MB80VAV4	7.302 €	1700 x 830 x 1428	+4°C/+12°C	230V/ 1ph/ 50Hz	4	-----	1000	1296
MB100VAV3	6.516 €	1400 x 1000 x 1428	+4°C/+12°C	230V/ 1ph/ 50Hz	3	-----	804	951
MB100VAV4	7.351 €	1700 x 1000 x 1428	+4°C/+12°C	230V/ 1ph/ 50Hz	4	-----	1000	1296

REFRIGERANTE · REFRIGERANT R290

Encimera de serie blanco. Incremento PVP por cambio de encimera [Consultar]. *White standar top. To change the top increase price [To consult].*

*En estos modelos no es posible colocar estructura para vidrio/pantalla superior.

Illuminación LED de serie
LED Lighting standard

MB100VAV4

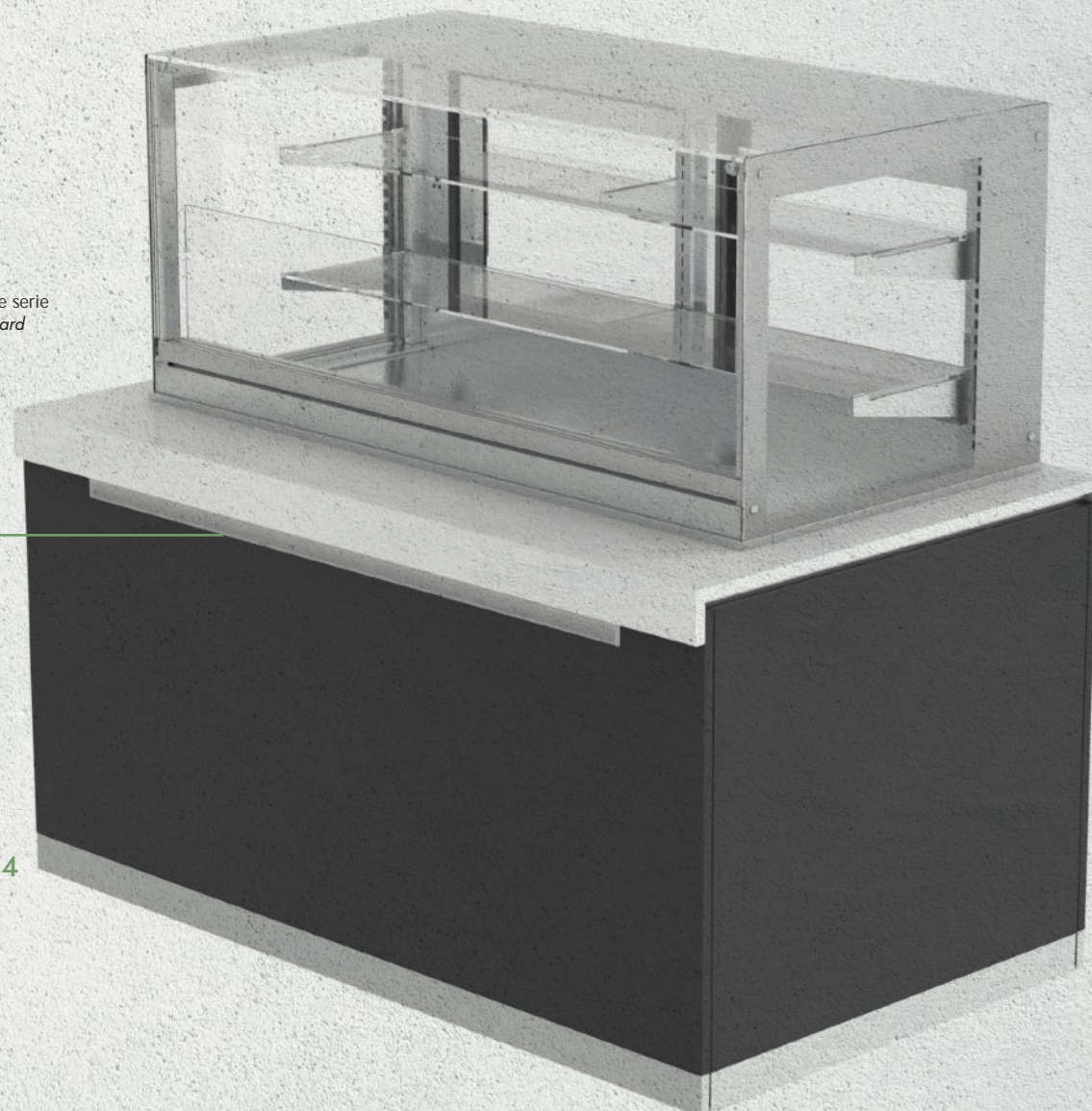

Serie Gastrobuffet Neutral · Series Gastrobuffet Neutral
Modelos · Models

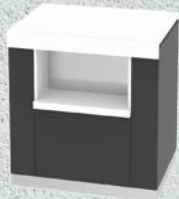

MB80NE2
1100 x 830 x 900 mm
2.665 €



MB80NE3
1400 x 830 x 900 mm
3.149 €



MB80NE4
1700 x 830 x 900 mm
3.486 €



MB80NE5
2025 x 830 x 900 mm
3.935 €



MB100NE2
1100 x 1000 x 900 mm
2.758 €



MB100NE3
1400 x 1000 x 900 mm
3.197 €



MB100NE4
1700 x 1000 x 900 mm
3.538 €

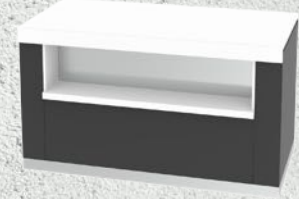

MB100NE5
2025 x 1000 x 900 mm
4.020 €

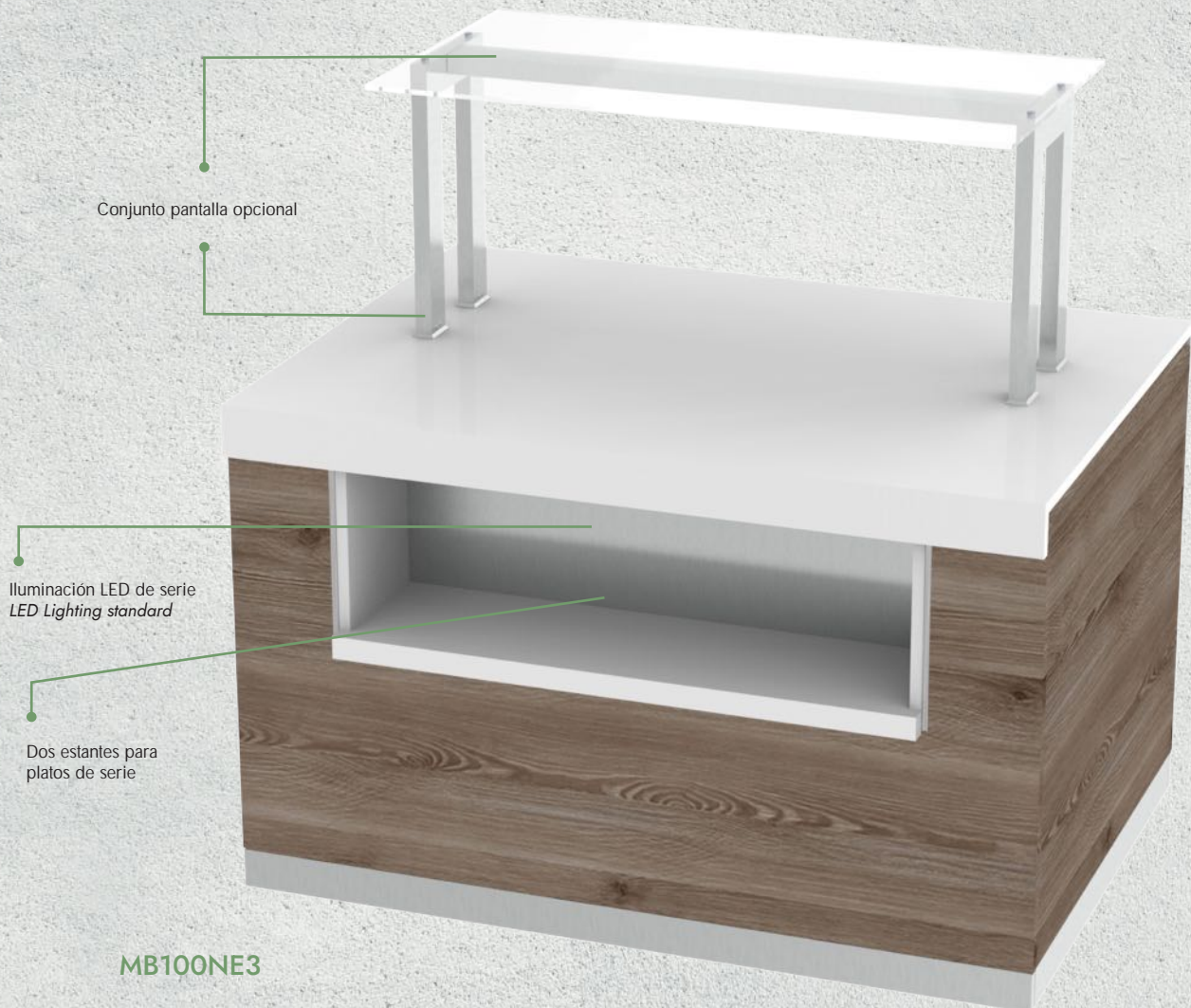

Serie Terminales · Series Terminals
Modelos · Models



MB80TL30
300 x 830 x 900 mm
1.965 €



MB80TL80
830 x 830 x 900 mm
2.741 €

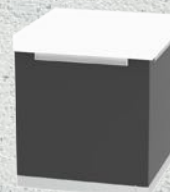

MB80ESQ
830 x 830 x 900 mm
2.109 €



MB100TL30
300 x 1000 x 900 mm
2.098 €



MB100TL100
1000 x 1000 x 900 mm
2.874 €

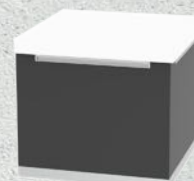

MB100ESQ
1000 x 1000 x 900 mm
2.241 €

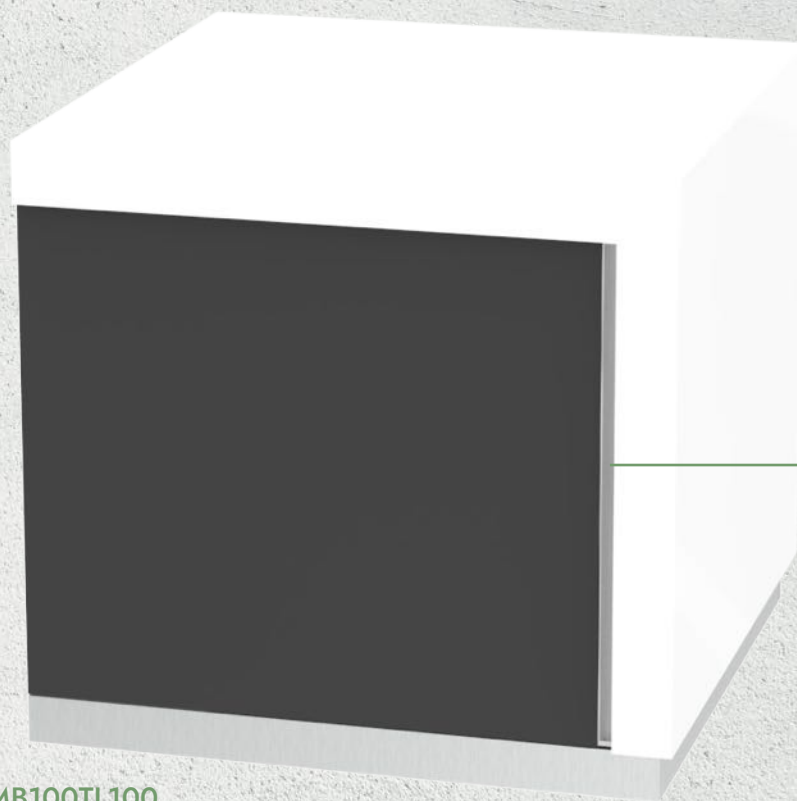

MB100TL100

Iluminación LED de serie
LED Lighting standard

Decoración Encimeras · Decoration Countertop



Estándar Blanco
Blanc Standard



Negro (Opcional)
Black (Optional)

* Otro color de encimera / acabado consultar precio · Other color, ask for price

INCREMENTO PRECIO CAMBIO ENCIMERAS A COLOR NEGRO · PRICE INCREASE FOR CHANGING COUNTERTOPS					
MODELO · Models	MB80-2GN / MB80-TL30	MB80-3GN	MB80-4GN	MB80-5GN	MB80-TL80 + Esquina / Terminal
PRECIO · PRICE	685 €	730 €	798 €	865 €	800 €
LARGO · LARGUE (mm)	830 - 1100 mm Terminal largo / Large Terminal 300mm	1400 mm	1700 mm	2025 mm	Terminal largo / Large Terminal 830 mm

INCREMENTO PRECIO CAMBIO ENCIMERAS A COLOR NEGRO† · PRICE INCREASE FOR CHANGING COUNTERTOPS					
MODELO · Models	MB100-2GN / MB100-TL30	MB100-3GN	MB100-4GN	MB100-5GN	MB100-TL100 + Esquina / Terminal
PRECIO · PRICE	696 €	752 €	822 €	892 €	892 €
LARGO · LARGUE (mm)	1100 mm Terminal largo / Large Terminal 300 mm	1400 mm	1700 mm	2025 mm	Terminal largo / Large Terminal 1000 mm

INCREMENTO PRECIO CAMBIO COLOR ESTANTE PARA PLATOS A COLOR NEGRO · PRICE INCREASE FOR CHANGING COLOR DISH RACK				
MODELO · Models	MB80-100-2GN-EST	MB80-100-3GN-EST	MB80-100-4GN-EST	MB80-100-5GN-EST
PRECIO · PRICE	324 €	347 €	365 €	392 €
LARGO · LARGUE (mm)	1100 mm	1400 mm	1700 mm	2025 mm

Color Decoración Decoration Colour

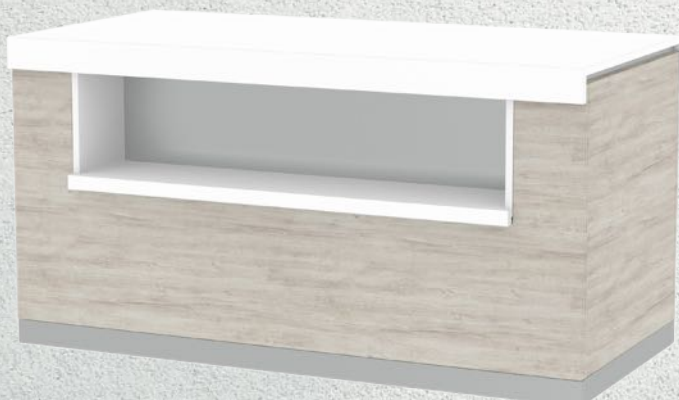

ANNIVERSARY O1OAK

Otro color consultar precio
Other colour consult price

Puede existir variación entre el color de esta impresión y el color real
There may be variation between print colour and true colour

Composición Conjunto Pantallas · Composition Set Screens

Dependiendo de las necesidades se pueden hacer las siguientes combinaciones para la composición de un conjunto completo:
 Depending on the requirements, these can be made the following combinations for the composition of a complete set:

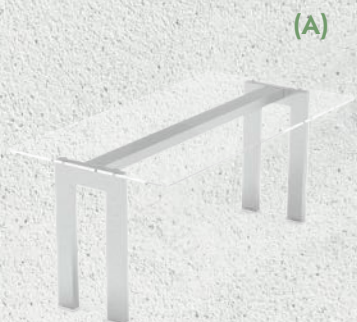

(A)

- A.**
*** Soporte 1 altura**
 - Soporte 1 altura: EEECU1
 - Pantalla ciega: EEPCU
 - Vidrio superior: EEVSU

- A.**
*** one height support**
 - Single height support: EEECU1
 - Screen: EEPCU
 - Glass top: EEVSU

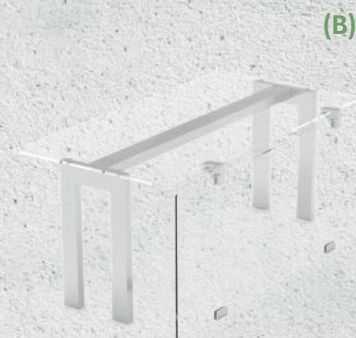

(B)

- B.**
*** Soporte 1 altura**
 - Soporte 1 altura: EEECU1
 - Pantalla (ciega, iluminación, infrarrojos, iluminación+infrarrojos)
 - Vidrio superior: EEVSU
 - Vidrio frontal: EEVFU

- B.**
*** one height support**
 - Single height support: EEECU1
 - Screen (lighting+ infrared)
 - Glass top: EEVSU
 - Front glass: EEVFU



(C)

- C.**
*** Soporte 2 alturas**
 - Soporte 2 altura: EEECU2
 - Pantalla (2un) (ciega, iluminación, infrarrojos, iluminación+infrarrojos)
 - Vidrio superior: EEVSU
 - Estante cristal: EEVEU

- C.**
*** Double height support**
 - Double height support: EEECU2
 - Screen (2units) (lighting + infrared)
 - Glass top: EEVSU
 - Glass shelf: EEVEU



(D)

- D.**
*** Soporte 2 alturas + vidrio frontal**
 - Soporte 2 altura: EEECU2
 - Pantalla (2un) (ciega, iluminación, infrarrojos, iluminación+infrarrojos)
 - Vidrio superior: EEVSU
 - Estante cristal: EEVEU
 - Vidrio frontal: EEVFU

- D.**
*** Double height and front glass**
 - Double height support: EEECU2
 - Screen (2units) (lighting and infrared)
 - Top Glass: EEVSU
 - Glass shelf: EEVEU
 - Front glass: EEVFU



(E)

- E.**
*** Pantalla Nueva**
 - Con iluminación: EEEBIU

- E.**
*** New Display**
 - EEEBIU lighting



(F)

- F.**
*** Nueva estructura con vidrio superior y tabicas**
 - Con infrarrojos EEEBIRU
 - Con vidrio superior EEVSU
 - Con tabicas EEVTU

- F.**
*** New structure with top glass and dividers**
 - EEEBIRU infrared
 - EEVSU top glass
 - EEVTU dividers

Soportes para Pantallas · Screen Supports



MODELO · Models	EEECU1	EEECU2
PRECIO · PRICE	292 €	572 €
ALTURA · HEIGHT (mm)	1	2
MEDIDAS · MEASURES (mm)	260 x 30 x 476	260 x 30 x 766

Tipo de Pantallas · Type of Screens



(A) Pantalla Iluminación
Lighting Screen

(A) PANTALLA ILUMINACIÓN / LIGHTING SCREEN				
MODELO · Models	EEKIU750	EEKIU1125	EEKIU1500	EEKIU2025
PRECIO · PRICE	266 €	274 €	285 €	299 €
MEDIDAS · MEASURES (mm)	710 x 74 x 36	1030 x 74 x 36	1350 x 74 x 36	1675 x 74 x 36
Para Módulos de: For Modules of:	2GN	3GN	4GN	5GN

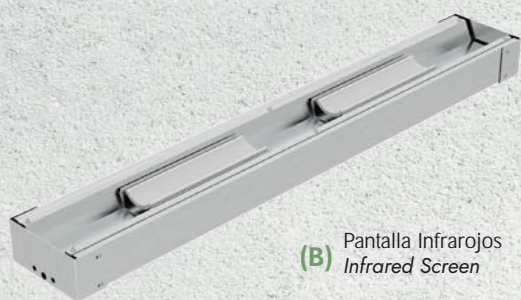

(B) Pantalla Infrarojos
Infrared Screen

(B) PANTALLA INFRAROJOS / INFRARED SCREEN				
MODELO · Models	EEKIRU750	EEKIRU1125	EEKIRU1500	EEKIRU2025
PRECIO · PRICE	345 €	436 €	531 €	599 €
MEDIDAS · MEASURES (mm)	710 x 155 x 74	1030 x 155 x 74	1350 x 155 x 74	1675 x 155 x 74
POTENCIA · POWER	500 W	1000 W	1500 W	2000 W
Para Módulos de: For Modules of:	2GN	3GN	4GN	5GN



(C) Pantalla Iluminación más Infrarojos
Lighting and Infrared Screen

(C) PANTALLA ILUMINACIÓN MÁS INFRAROJOS / LIGHTING AND INFRARED SCREEN				
MODELO · Models	EEKIRLU750	EEKIRLU1125	EEKIRLU1500	EEKIRLU2025
PRECIO · PRICE	447 €	544 €	661 €	755 €
MEDIDAS · MEASURES (mm)	710 x 248 x 74	1030 x 248 x 74	1350 x 248 x 74	1675 x 248 x 74
POTENCIA · POWER	500 W	1000 W	1500 W	2000 W
Para Módulos de: For Modules of:	2GN	3GN	4GN	5GN



(D) Estructura Sólida
Solid Structure

(D) ESTRUCTURA SÓLIDA · SOLID STRUCTURE				
ILUMINACIÓN	EEEBIU750	EEEBIU1125	EEEBIU1500	EEEBIU2025
PRECIO · PRICE	281 €	308 €	339 €	376 €
INFRAROJOS	EEEBIRU750	EEEBIRU1125	EEEBIRU1500	EEEBIRU2025
POTENCIA	500 W	1000 W	1500 W	2000 W
PRECIO · PRICE	360 €	470 €	585 €	676 €
ILUMINACIÓN MÁS INFRAROJOS	EEEBIRLU750	EEEBIRLU1125	EEEBIRLU1500	EEEBIRLU2025
POTENCIA	500 W	1000 W	1500 W	2000 W
PRECIO · PRICE	462 €	578 €	715 €	832 €
MEDIDAS-MEASURES (mm)	772 x 151 x 475	1092 x 151 x 475	1412 x 151 x 475	1737 x 151 x 475
PARA MÓDULOS DE	2GN	3GN	4GN	5GN



(E) Vidrio Superior
Glass Top

(E) VIDRIO SUPERIOR/GLASS TOP				
MODELO · Models	EEVSU750	EEVSU1125	EEVSU1500	EEVSU2025
PRECIO · PRICE	104 €	112 €	127 €	147 €
MEDIDAS-MEASURES (mm)	790 x 590 x 8	1110 x 590 x 8	1430 x 590 x 8	1755 x 590 x 8
Para Módulos de: For Modules of:	2GN	3GN	4GN	2025 (5GN)

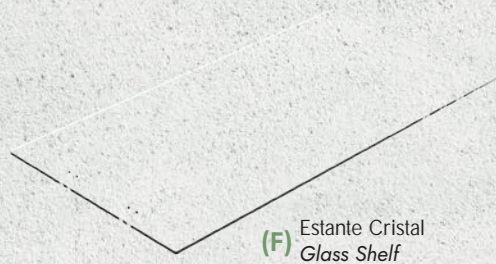

(F) Estante Cristal
Glass Shelf

(F) ESTANTE CRISTAL/ GLASS SHELF				
MODELO · Models	EEVEU750	EEVEU1125	EEVEU1500	EEVEU2025
PRECIO · PRICE	85 €	97 €	114 €	129 €
MEDIDAS-MEASURES (mm)	705 x 470 x 8	1025 x 470 x 8	1345 x 470 x 8	1670 x 470 x 8
Para Módulos de: For Modules of:	2GN	3GN	4GN	2025 (5GN)

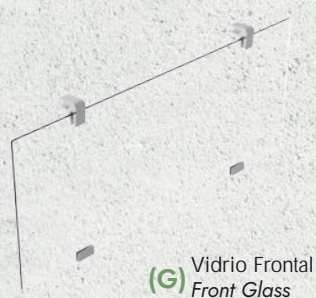

(G) Vidrio Frontal
Front Glass

(G) VIDRIO FRONTAL / FRONT GLASS				
MODELO · Models	EEVFU750	EEVFU1125	EEVFU1500	EEVFU2025
PRECIO · PRICE	210 €	224 €	236 €	248 €
MEDIDAS-MEASURES (mm)	790 x 460 x 8	1110 x 460 x 8	1430 x 460 x 8	1755 x 460 x 8
Para Módulos de: For Modules of:	2GN	3GN	4GN	2025 (5GN)

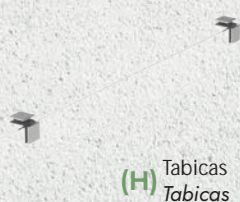

(H) Tabicas
Tabicas

(H) TÁBICAS · TÁBICAS				
Para Módulos de: For Modules of:	2GN (750)	3GN (1125)	4GN (1500)	5GN (2025)
PRECIO · PRICE	164 €	172 €	179 €	186 €
MEDIDAS-MEASURES (mm)	790 x 100 x 8	1110 x 100 x 8	1430 x 100 x 8	1755 x 100 x 8



03. DPRO



DRÖPLIN

Encastrables

EEVAV3



Un *diseño* eficiente

An efficient design



Elementos Encastrables Baño María · *Baño María Ventilada*
Drop in Bain Marie · *Ventilated Bain Marie*
Modelos · Models

Elementos Encastrables Baño María · *Drop in Bain Marie*



EEBM2



EEBM3



EEBM4



EEBM5

Elementos Encastrables Baño María Ventilado · *Drop in Ventilated Bain Marie*



EEBMV3



EEBMV4



EEBM4



MODELO Models	PRECIO Price	MEDIDAS Measures (mm)	MEDIDAS DE ENCASTRE Fitting dimensions (mm)	TEMPERATURA Temperature (°C)	TENSIÓN - FRECUENCIA Electrical data	MATERIAL Material	CUBETA Tank	POTENCIA Power (W)
EEBM2	1.313 €	815 x 650 x 380	780 x 615	+30°C/+90°C	230V / 1ph / 50Hz	AISI 304	2	1500
EEBM3	1.674 €	1135 x 650 x 380	1100 x 615	+30°C/+90°C	230V/ 1ph / 50Hz*	AISI 304	3	2500
EEBM4	1.996 €	1455 x 650 x 380	1420 x 615	+30°C/+90°C	400V/3ph/50Hz	AISI 304	4	3500
EEBM5	2.360 €	1775 x 650 x 380	1740 x 615	+30°C/+90°C	400V/3ph/50Hz	AISI 304	5	4500
EEBMV3	1.484 €	1135 x 650 x 460	1100 x 615	+30°C/+90°C	230V/ 1ph / 50Hz*	AISI 304	3	1040
EEBMV4	1.670 €	1455 x 650 x 460	1420 x 615	+30°C/+90°C	230V/ 1ph / 50Hz*	AISI 304	4	2080

*Infrarrojos >3000W → 400V/3ph/50Hz · *Infrared >3000W → 400V/3ph/50Hz

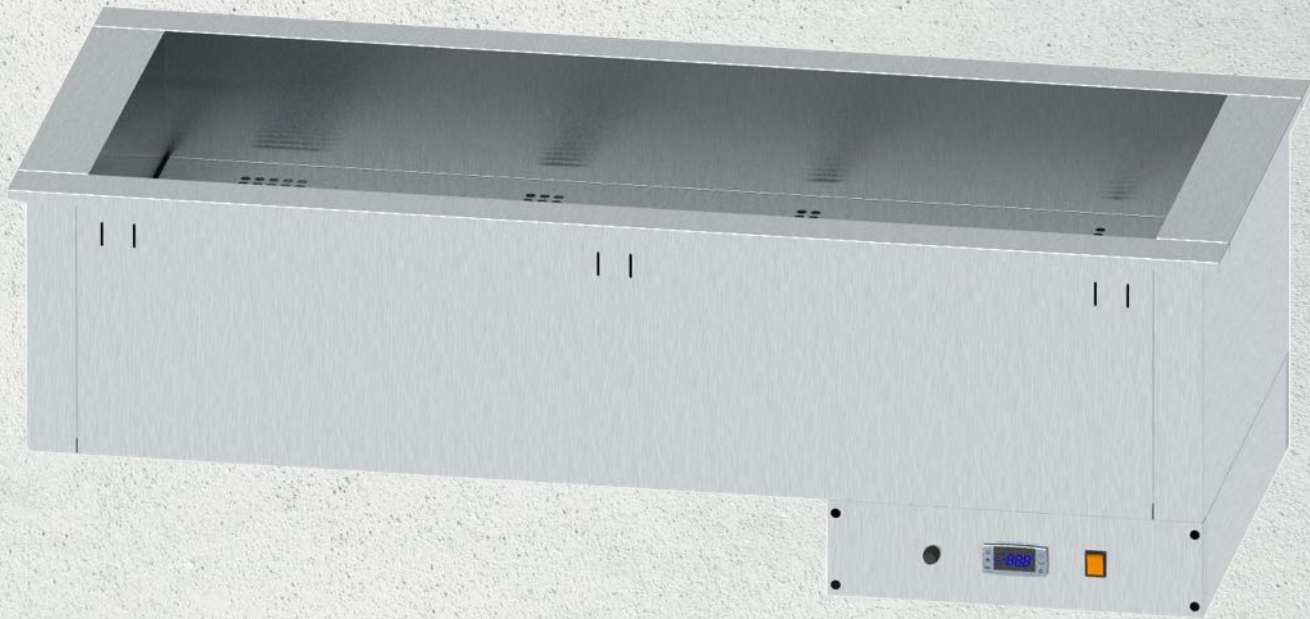

EEBMV4

Elementos Encastrables Placa Fría · Drop in Cold Tray

Modelos · Models



EEPF3



EEPF4



EEPF5



EECH4



EEPF3



EEPF4



MODELO Models	PRECIO Price	MEDIDAS Measures (mm)	MEDIDAS DE ENCASTRE Fitting dimensions (mm)	TEMPERATURA Temperature (°C)	TENSIÓN ·FRECUENCIA Electrical Data	MATERIAL Material	CUBETA Tank	POTENCIA Power (W)	POTENCIA FRIG. Cooling capacity (W A -10°C)
EEPF3	1.404 €	1135 x 650 x 490	1100 x 615	-4°C/+4°C	230V / 1ph / 50Hz	AISI 304	—	223	370
EEPF4	1.469 €	1455 x 650 x 490	1420 x 615	-4°C/+4°C	230V / 1ph / 50Hz	AISI 304	—	223	370
EEPF5	1.718 €	1775 x 650 x 490	1740 x 615	-4°C/+4°C	230V / 1ph / 50Hz	AISI 304	—	382	687
EECH4	1.611 €	815 x 530 x 595	780 x 495	-12°C / -18°C	230V / 1ph / 50Hz	AISI 304	*4	309	306

REFRIGERANTE · REFRIGERANT R290

* Para 4 cubetas de helados

EECH4
Helados
Ice Cream



Elementos Encastrables Cuba Fría · Drop in Cold Tank

Modelos · Models



EECF2



EECF3



EECF4



EECF5



MODELO Models	PRECIO Price	MEDIDAS Measures (mm)	MEDIDAS DE ENCASTRE Fitting dimensions (mm)	TEMPERATURA Temperature (°C)	TENSIÓN -FRECUENCIA Electrical data	MATERIAL Material	CUBETA Tank	POTENCIA Power (W)	POTENCIA FRIG. Cooling capacity (W A -10°C)
EECF2	1.590 €	815 x 650 x 645	780 x 615	+2°C/+10°C	230V / 1ph / 50Hz	AISI 304	2	223	370
EECF3	1.931 €	1135 x 650 x 645	1100 x 615	+2°C/+10°C	230V / 1ph / 50Hz	AISI 304	3	223	370
EECF4	2.064 €	1455 x 650 x 645	1420 x 615	+2°C/+10°C	230V / 1ph / 50Hz	AISI 304	4	223	370
EECF5	2.152 €	1775 x 650 x 645	1740 x 615	+2°C/+10°C	230V / 1ph / 50Hz	AISI 304	5	382	687

REFRIGERANTE · REFRIGERANT R290



EECF3



EECF4



EECF5

Elementos Encastrables Cuba Fría Ventilada · Drop in Ventilated Cold Tank

Modelos · Models



EECFV3



EECFV4



EECFV5



MODELO Models	PRECIO Price	MEDIDAS Measures (mm)	MEDIDAS DE ENCASTRE Fitting dimensions (mm)	TEMPERATURA Temperature (°C)	TENSIÓN - FRECUENCIA Electrical data	MATERIAL Material	CUBETA Tank	POTENCIA Power (W)	POTENCIA FRIG. Cooling capacity (W A -10°C)
EECFV3	2.374 €	1155 x 745 x 800	1100 x 690	+2°C/+10°C	230V / 1ph / 50Hz	AISI 304	3	637	687
EECFV4	2.628 €	1475 x 745 x 800	1420 x 690	+2°C/+10°C	230V / 1ph / 50Hz	AISI 304	4	637	687
EECFV5	3.367 €	1804 x 745 x 800	1750 x 690	+2°C/+10°C	230V / 1ph / 50Hz	AISI 304	5	1212	1296

REFRIGERANTE · REFRIGERANT R290

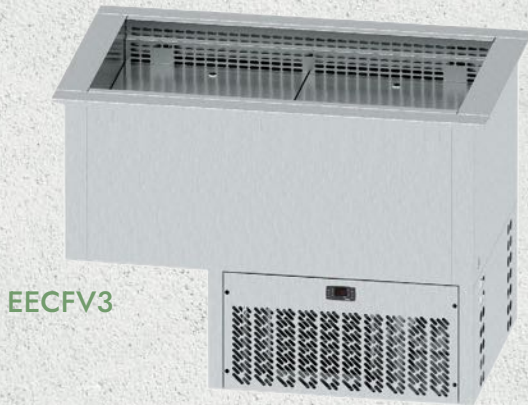

EECFV3



EECFV5

Elementos Encastrables Vitrina con Cortina · Vitrina con Vidrio Delantero Abatible
Drop In with fitted night curtain · Hinged doors & frontal glass
Modelos · Models



EEVMC3



EEVMC4



EEVAV3

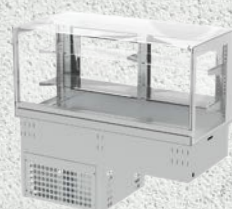

EEVAV4



EEVAB3



EEVAB4

Iluminación LED de serie
LED Lighting standard



EEVMC3



MODELO Models	PRECIO Price	MEDIDAS Measures (mm)	MEDIDAS DE ENCASTRE Fitting dimensions (mm)	TEMPERATURA Temperature (°C)	TENSIÓN · FRECUENCIA Electrical data	MATERIAL Material	POTENCIA Power (W)	POTENCIA FRIG. Cooling capacity (W A -10°C)
EEVMC3	4.123 €	1135 x 765 x 1537	1100 x 690	+4°C/+12°C	230V / 1ph / 50Hz	AISI 304	1246	1296
EEVMC4	4.720 €	1455 x 765 x 1537	1420 x 690	+4°C/+12°C	230V / 1ph / 50Hz	AISI 304	1646	1805
EEVAV3	4.337 €	1135 x 765 x 1215	1100 x 690	+4°C/+12°C	230V / 1ph / 50Hz	AISI 304	804	951
EEVAV4	5.371 €	1455 x 765 x 1215	1420 x 690	+4°C/+12°C	230V / 1ph / 50Hz	AISI 304	1000	1296
EEVAB3	2.655 €	1135 x 765 x 777	1100 x 690	+4°C/+12°C	230V / 1ph / 50Hz	AISI 304	437	687
EEVAB4	2.894 €	1455 x 765 x 777	1420 x 690	+4°C/+12°C	230V / 1ph / 50Hz	AISI 304	437	687

REFRIGERANTE · REFRIGERANT **R290**

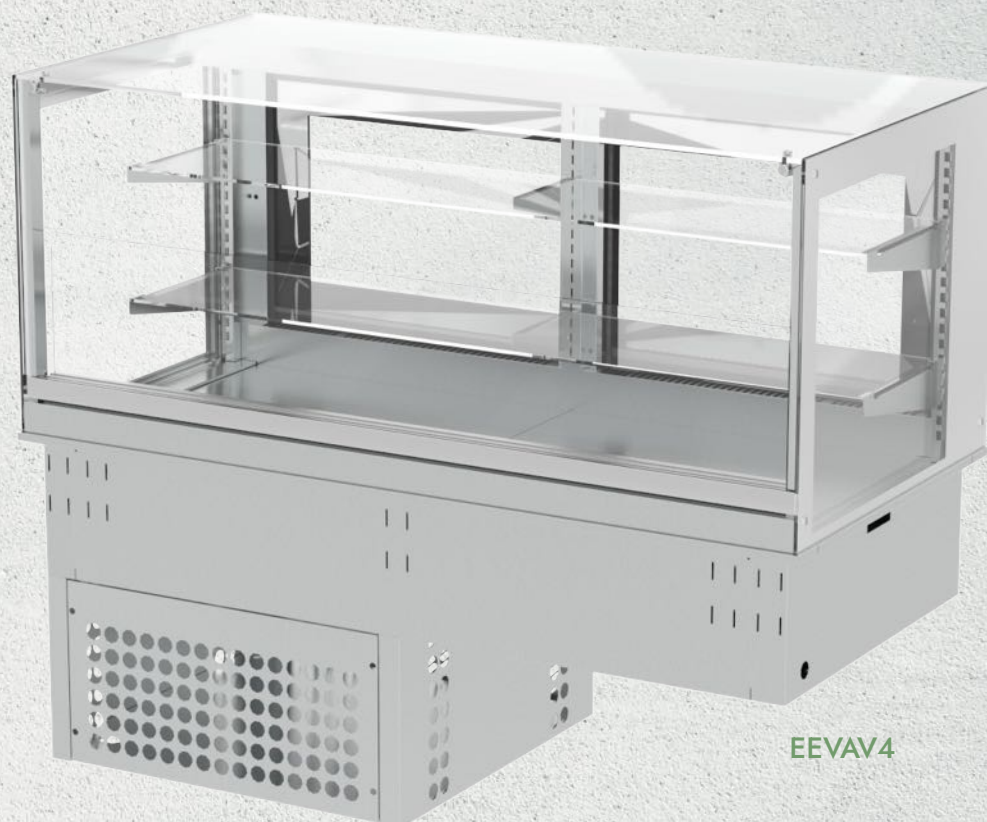

EEVAV4

Elementos Encastrables Vitrocerámica · Drop in glass-ceramic hob

Modelos · Models



EEVC2



EEVC3



EEVC4



	MODELO Models	PRECIO Price	MEDIDAS Measures (mm)	MEDIDAS DE ENCASTRE Fitting dimensions (mm)	TEMPERATURA Temperature (°C)	TENSIÓN · FRECUENCIA Electrical data	MATERIAL Material	POTENCIA Power (W)
Vidrio Scott Scott Glass	EEVC2	1.884 €	815 x 650 x 225	780 x 615	Max. +130°C	230V / 1ph / 50Hz	AISI 304	900
	EEVC3	2.187 €	1135 x 650 x 225	1100 x 615	Max. +130°C	230V/ 1ph / 50Hz*	AISI 304	1350
	EEVC4	3.377 €	1455 x 650 x 225	1420 x 615	Max. +130°C	230V/ 1ph / 50Hz*	AISI 304	1800
Vidrio Templado Tempered Glass	EEVC2_E	1.204 €	815 x 650 x 225	780 x 615	Max. +90°C	230V/ 1ph/ 50Hz	AISI 304	570
	EEVC3_E	1.392 €	1135 x 650 x 225	1100 x 615	Max. +90°C	230V/ 1ph/ 50Hz	AISI 304	855
	EEVC4_E	1.929 €	1455 x 650 x 225	1420 x 615	Max. +90°C	230V/ 1ph/ 50Hz*	AISI 304	1140

*Infrarrojos >3000W → 400V/3ph/50Hz · *Infrared >3000W → 400V/3ph/50Hz

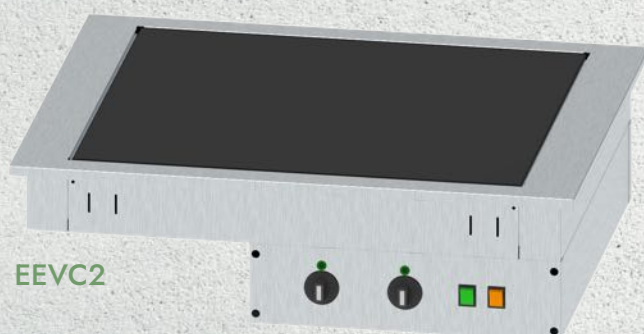

EEVC2

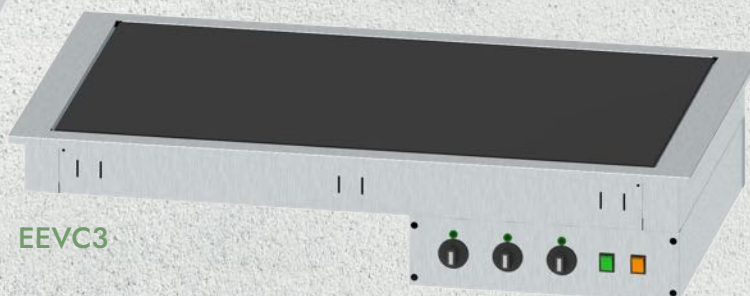

EEVC3

Composición Conjunto Pantallas · Composition Set Screens

Dependiendo de las necesidades se pueden hacer las siguientes combinaciones para la composición de un conjunto completo:
 Depending on the requirements, these can be made the following combinations for the composition of a complete set:

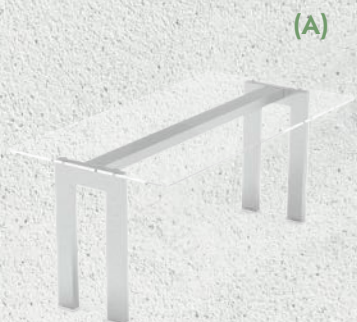

(A)

- A.**
*** Soporte 1 altura**
 - Soporte 1 altura: EEECU1
 - Pantalla ciega: EEPCU
 - Vidrio superior: EEVSU

- A.**
*** one height support**
 - Single height support: EEECU1
 - Screen: EEPCU
 - Glass top: EEVSU



(B)

- B.**
*** Soporte 1 altura**
 - Soporte 1 altura: EEECU1
 - Pantalla (ciega, iluminación, infrarrojos, iluminación+infrarrojos)
 - Vidrio superior: EEVSU
 - Vidrio frontal: EEVFU

- B.**
*** one height support**
 - Single height support: EEECU1
 - Screen (lighting+ infrared)
 - Glass top: EEVSU
 - Front glass: EEVFU



(C)

- C.**
*** Soporte 2 alturas**
 - Soporte 2 altura: EEECU2
 - Pantalla (2un) (ciega, iluminación, infrarrojos, iluminación+infrarrojos)
 - Vidrio superior: EEVSU
 - Estante cristal: EEVEU

- C.**
*** Double height support**
 - Double height support: EEECU2
 - Screen (2units) (lighting + infrared)
 - Glass top: EEVSU
 - Glass shelf: EEVEU



(D)

- D.**
*** Soporte 2 alturas + vidrio frontal**
 - Soporte 2 altura: EEECU2
 - Pantalla (2un) (ciega, iluminación, infrarrojos, iluminación+infrarrojos)
 - Vidrio superior: EEVSU
 - Estante cristal: EEVEU
 - Vidrio frontal: EEVFU

- D.**
*** Double height and front glass**
 - Double height support: EEECU2
 - Screen (2units) (lighting and infrared)
 - Top Glass: EEVSU
 - Glass shelf: EEVEU
 - Front glass: EEVFU



(E)

- E.**
*** Pantalla Nueva**
 - Con iluminación: EEEBIU

- E.**
*** New Display**
 - EEEBIU lighting



(F)

- F.**
*** Nueva estructura con vidrio superior y tabicas**
 - Con infrarrojos EEEBIRU
 - Con vidrio superior EEVSU
 - Con tabicas EEVTU

- F.**
*** New structure with top glass and dividers**
 - EEEBIRU infrared
 - EEVSU top glass
 - EEVTU dividers

Soportes para Pantallas · Screen Supports



MODELO · Models	EEECU1	EEECU2
PRECIO · PRICE	292 €	572 €
ALTURA · HEIGHT (mm)	1	2
MEDIDAS · MEASURES (mm)	260 x 30 x 476	260 x 30 x 766

Tipo de Pantallas · Type of Screens



(A) Pantalla Iluminación
Lighting Screen

(A) PANTALLA ILUMINACIÓN / LIGHTING SCREEN				
MODELO · Models	EEKIU750	EEKIU1125	EEKIU1500	EEKIU2025
PRECIO · PRICE	266 €	274 €	285 €	299 €
MEDIDAS · MEASURES (mm)	710 x 74 x 36	1030 x 74 x 36	1350 x 74 x 36	1675 x 74 x 36
Para Módulos de: For Modules of:	2GN	3GN	4GN	5GN

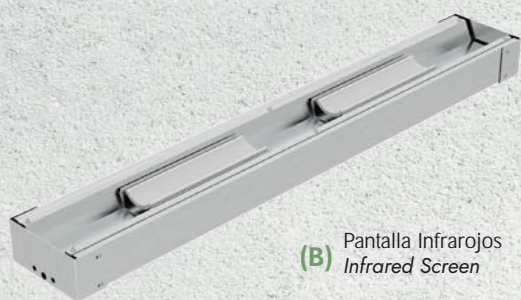

(B) Pantalla Infrarojos
Infrared Screen

(B) PANTALLA INFRAROJOS / INFRARED SCREEN				
MODELO · Models	EEKIRU750	EEKIRU1125	EEKIRU1500	EEKIRU2025
PRECIO · PRICE	345 €	436 €	531 €	599 €
MEDIDAS · MEASURES (mm)	710 x 155 x 74	1030 x 155 x 74	1350 x 155 x 74	1675 x 155 x 74
POTENCIA · POWER	500 W	1000 W	1500 W	2000 W
Para Módulos de: For Modules of:	2GN	3GN	4GN	5GN



(C) Pantalla Iluminación más Infrarojos
Lighting and Infrared Screen

(C) PANTALLA ILUMINACIÓN MÁS INFRAROJOS / LIGHTING AND INFRARED SCREEN				
MODELO · Models	EEKIRLU750	EEKIRLU1125	EEKIRLU1500	EEKIRLU2025
PRECIO · PRICE	447 €	544 €	661 €	755 €
MEDIDAS · MEASURES (mm)	710 x 248 x 74	1030 x 248 x 74	1350 x 248 x 74	1675 x 248 x 74
POTENCIA · POWER	500 W	1000 W	1500 W	2000 W
Para Módulos de: For Modules of:	2GN	3GN	4GN	5GN



(D) Estructura Sólida
Solid Structure

(D) ESTRUCTURA SÓLIDA · SOLID STRUCTURE				
ILUMINACIÓN	EEEBIU750	EEEBIU1125	EEEBIU1500	EEEBIU2025
PRECIO · PRICE	281 €	308 €	339 €	376 €
INFRAROJOS	EEEBIRU750	EEEBIRU1125	EEEBIRU1500	EEEBIRU2025
POTENCIA	500 W	1000 W	1500 W	2000 W
PRECIO · PRICE	360 €	470 €	585 €	676 €
ILUMINACIÓN MÁS INFRAROJOS	EEEBIRLU750	EEEBIRLU1125	EEEBIRLU1500	EEEBIRLU2025
POTENCIA	500 W	1000 W	1500 W	2000 W
PRECIO · PRICE	462 €	578 €	715 €	832 €
MEDIDAS-MEASURES (mm)	772 x 151 x 475	1092 x 151 x 475	1412 x 151 x 475	1737 x 151 x 475
PARA MÓDULOS DE	2GN	3GN	4GN	5GN



(E) Vidrio Superior
Glass Top

(E) VIDRIO SUPERIOR/GLASS TOP				
MODELO · Models	EEVSU750	EEVSU1125	EEVSU1500	EEVSU2025
PRECIO · PRICE	104 €	112 €	127 €	147 €
MEDIDAS-MEASURES (mm)	790 x 590 x 8	1110 x 590 x 8	1430 x 590 x 8	1755 x 590 x 8
Para Módulos de: For Modules of:	2GN	3GN	4GN	2025 (5GN)

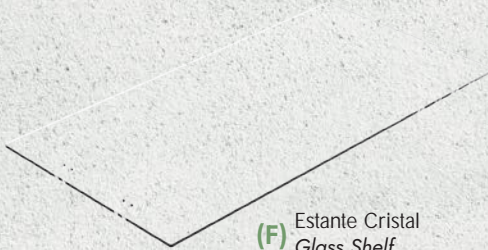

(F) Estante Cristal
Glass Shelf

(F) ESTANTE CRISTAL/ GLASS SHELF				
MODELO · Models	EEVEU750	EEVEU1125	EEVEU1500	EEVEU2025
PRECIO · PRICE	85 €	97 €	114 €	129 €
MEDIDAS-MEASURES (mm)	705 x 470 x 8	1025 x 470 x 8	1345 x 470 x 8	1670 x 470 x 8
Para Módulos de: For Modules of:	2GN	3GN	4GN	2025 (5GN)

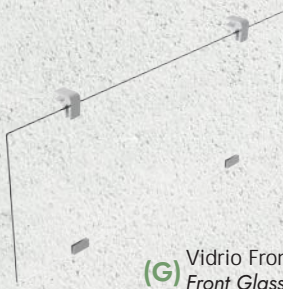

(G) Vidrio Frontal
Front Glass

(G) VIDRIO FRONTAL / FRONT GLASS				
MODELO · Models	EEVFU750	EEVFU1125	EEVFU1500	EEVFU2025
PRECIO · PRICE	210 €	224 €	236 €	248 €
MEDIDAS-MEASURES (mm)	790 x 460 x 8	1110 x 460 x 8	1430 x 460 x 8	1755 x 460 x 8
Para Módulos de: For Modules of:	2GN	3GN	4GN	2025 (5GN)

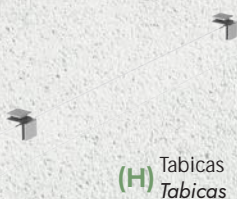

(H) Tabicas
Tabicas

(H) TÁBICAS · TÁBICAS				
Para Módulos de: For Modules of:	2GN (750)	3GN (1125)	4GN (1500)	5GN (2025)
PRECIO · PRICE	164 €	172 €	179 €	186 €
MEDIDAS-MEASURES (mm)	790 x 100 x 8	1110 x 100 x 8	1430 x 100 x 8	1755 x 100 x 8

Drop In calientes · Hot Drop In

Cocción a Gas Gas Cooker

Modelos · Models



Plano de cocción a gas
2 fuegos

*Layout of gas cooker
with 2 hobs*

EEDCPG35G

Cocción Eléctrica Electric Cooker

Modelos · Models



Plano de cocción eléctrico
2 fuegos diámetro 220mm

*Layout of electric cooker
with 2 hobs measuring
220mm*

EEDPC35E0

Cocción Vitrocerámica Vitroceramic Cooker

Modelos · Models



Plano de cocción
Vitrocerámica 2 fuegos

*Layout of vitroceramic
cooker with 2 hobs*

EEDPCC35E0



Plano de cocción a gas
4 fuegos

*Layout of gas cooker
with 4 hobs*

EEDCPG70G



Plano de cocción eléctrico
4 fuegos diámetro 220mm

*Layout of electric cooker
with 4 hobs measuring
220mm*

EEDPC70E0



Plano de cocción
Vitrocerámica 4 fuegos

*Layout of vitroceramic
cooker with 4 hobs*

EEDPCC70E0



EEDCPG35G



EEDPC35E0



	MODELO Models	PRECIO PRICE	MEDIDAS TOTALES MEASURES (mm)	MEDIDAS ENCASTRE MEASURES (mm)	TENSIÓN FRECUENCIA ELECTRICAL DATA	POTENCIA FUEGOS PLATES SHELF (Kw)	POTENCIA TOTAL POWER (Kw)	QUEMADORES QUEMADORES
Cocción Gas Gas Cooker	EEDCPG35G	1.236 €	350 x 600 x 307	340 x 590	—	3,3 Kw + 5,2 KW	8,5 KW	2
	EEDCPG70G	1.934 €	700 x 600 x 307	690 x 590	—	2 de 3,3 KW + 2 de 5,2 KW	17 KW	4
Cocción Eléctrica Electric Cooker	EEDPC35E0	755 €	350 x 600 x 266	340 x 590	*230V / 50 - 60 Hz	2,6 Kw+2,6 KW	5,2 KW	2
	EEDPC70E0	1.339 €	700 x 600 x 266	690 x 590	400V/3N/50-60Hz	4 de 2,6 KW	10,4KW	4
Cocción Vitrocerámica Vitroceramic Cooker	EEDPCC35E0	1.586 €	350 x 600 x 266	340 x 590	400V/2N/50-60Hz	1,8 Kw + 2,5 KW	4,3 KW	2
	EEDPCC70E0	2.594 €	700 x 600 x 266	690 x 590	*230V / 50 - 60 Hz	2 de 1,8 KW + 2 de 2,5 KW	8,6KW	4

*Distinta tensión consultar Catálogo Kitchen Line by Infrico

*Different voltages see Kitchen Line by Infrico catalog.



EEDPCC70E0

Drop In calientes · Hot Drop In

Cocción Inducción Induction Cooker

Modelos · Models



Plano de cocción
Inducción 2 fuegos

Layout of induction
cooker with 2 hobs

EEDPIN35E

Baño María Eléctrico Electric Bain Marie

Modelos · Models



Baños maría eléctrico
GN 1/1

GN 1/1 Electric
Bain Marie

EEDBM35E0

Mantenedor patatas fritas Hot Reserve for fries

Modelos · Models



Mantenedor eléctrico GN
2/3 Patatas fritas

GN 2/3 Electric hot
reserve for fries

EEDSP35E0



Freidoras eléctricas 8L

8L Electric fryers

EEDFR35E0



Baños maría eléctrico
GN 2/1

GN 2/1 Electric
Bain Marie

EEDBM70E0



Freidoras eléctricas 8L+8L

8L+ 8L Electric hobs

EEDFR35E0



EEDPIN35E



EEDSP35E0



	MODELO Models	PRECIO PRICE	MEDIDAS TOTALES MEASURES (mm)	MEDIDAS ENCASTRE MEASURES (mm)	TENSIÓN FRECUENCIA ELECTRICAL DATA	POTENCIA FUEGOS PLATES SHELF (Kw)	POTENCIA TOTAL POWER (Kw)	QUEMADORES QUEMADORES
Cocción Inducción Induction Cooker	EEDPIN35E	6.693 €	350 x 650 x 295	340 x 590	400V/3N/50-60Hz	3,5Kw+3,5KW	7 KW	2
	EEDFR35ESO	1.349 €	350 x 600 x 330	340 x 590	*400V/3N/50-60Hz	**7,5 KW	7,5 KW	1
	EEDFR70ESO	2.261 €	700 x 600 x 330	690 x 590	*400V/3N/50-60Hz	**7,5Kw+7,5KW	15 KW	2
Baño María Eléctrico Electric Bain Marie	EEDBM35EO	874 €	350 x 600 x 266	340 x 590	230V/50-60Hz	1,3KW	1,3KW	1
	EEDBM70EO	1.140 €	700 x 600 x 266	690 x 590	230V/50-60Hz	2,6KW	2,6KW	1
Mantenedor patatas fritas Hot Reserve for fries	EEDSP35EO	1.198 €	350 x 600 x 266	340 x 590	225-240V/50-60Hz	0,65KW	0,65 KW	1

*Distinta tensión consultar Catálogo Kitchen Line by Infrico

*Different voltages see Kitchen Line by Infrico catalog

**Potencia de 6KW consultar Catálogo Kitchen Line by Infrico

**Power of see Kitchen Line by Infrico catalog

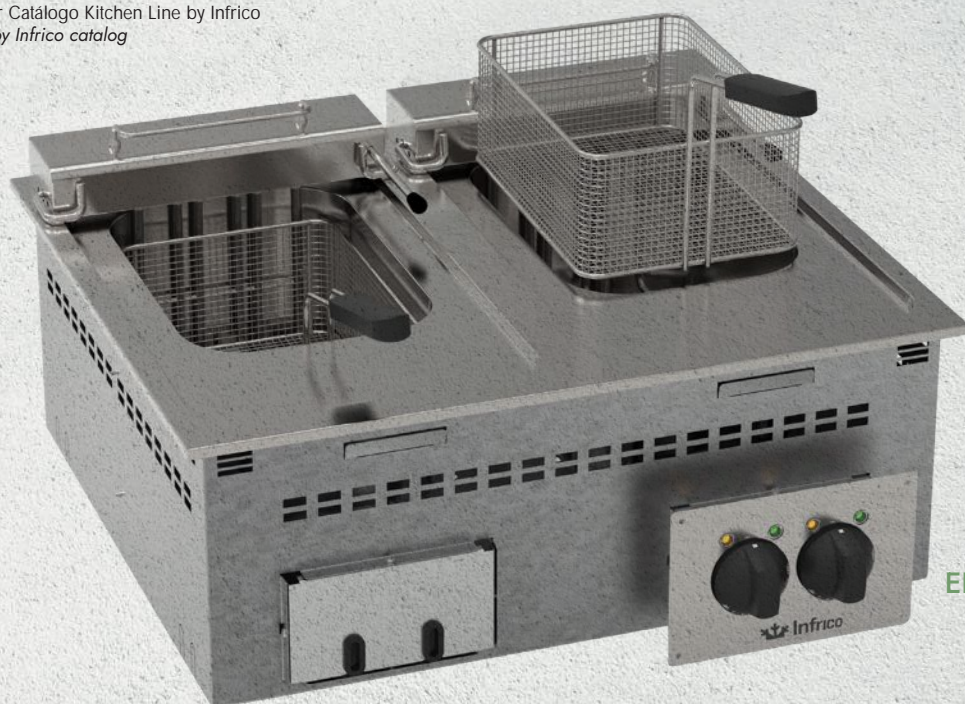

EEDFR35ESO

Drop In calientes · Hot Drop In

Cuecepasta Eléctrico Electric Pasta Cooker

Modelos · Models



Cuecepasta eléctrico
23L GN 2/3

23L GN 2/3
Electric pasta cooker

EEDCP35E0

Fry Top Eléctrico Fry Top electric flat grill

Modelos · Models



Fry top eléctrico
plancha lisa

Fry top
Electric Flat grill

EEDFTL35E0



Fry top eléctrico doble
plancha lisa

Double Fry top
Electric Flat grill

EEDFTL70E0

Accesorios Cuecepasta Eléctrico Accessories for Electric Pasta Cooker

Modelos · Models

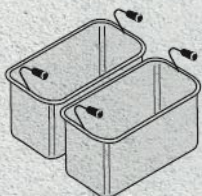

2 Cestas GN 1/3
2 GN 1/3 Baskets

EE120620

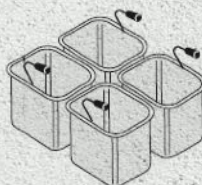

4 Cestas GN 1/6
4 GN 1/6 Baskets

EE120625

EEDFTL35E0



EEDCP35E0





	MODELO Models	PRECIO PRICE	MEDIDAS TOTALES MEASURES (mm)	MEDIDAS ENCASTRE MEASURES (mm)	TENSIÓN FRECUENCIA ELECTRICAL DATA	POTENCIA FUEGOS PLATES SHELF (Kw)	POTENCIA TOTAL POWER (Kw)	QUEMADORES QUEMADORES
Cuecepasta Eléctrico Electric Pasta Cooker	EEDCP35EO	2.389 €	350 x 600 x 320	340 x 590 mm	400V/3N/50-60Hz	4,8KW	4,8KW	1
Acc. Cuecepasta Eléctrico Acc for Electric Pasta Cooker	EE120620	321 €	290 x 160 x 200	—	—	—	—	—
	EE120625	412 €	140 x 140 x 200	—	—	—	—	—
Fry Top Eléctrico Fry Top electric flat grill	EEDFTL35EO	1.217 €	350 x 600 x 266	340 x 590	*400V/2N/50-60Hz	—	*3,9 KW	1
	EEDFTL70EO	1.699 €	700 x 600 x 266	690 x 590	400V/3N/50-60Hz	—	7,8 KW	2

*Más opciones ver Catálogo Kitchen Line by Infrico
 *More options see Kitchen Line by Infrico catalog



EEDFTL70EO



04. S



NUEVO
NEW

SELF. service

SSCFF4



Un autoservicio *de primera*

A first-class self-service



CARÁCTERÍSTICAS GENERALES

GENERAL CHARACTERISTICS

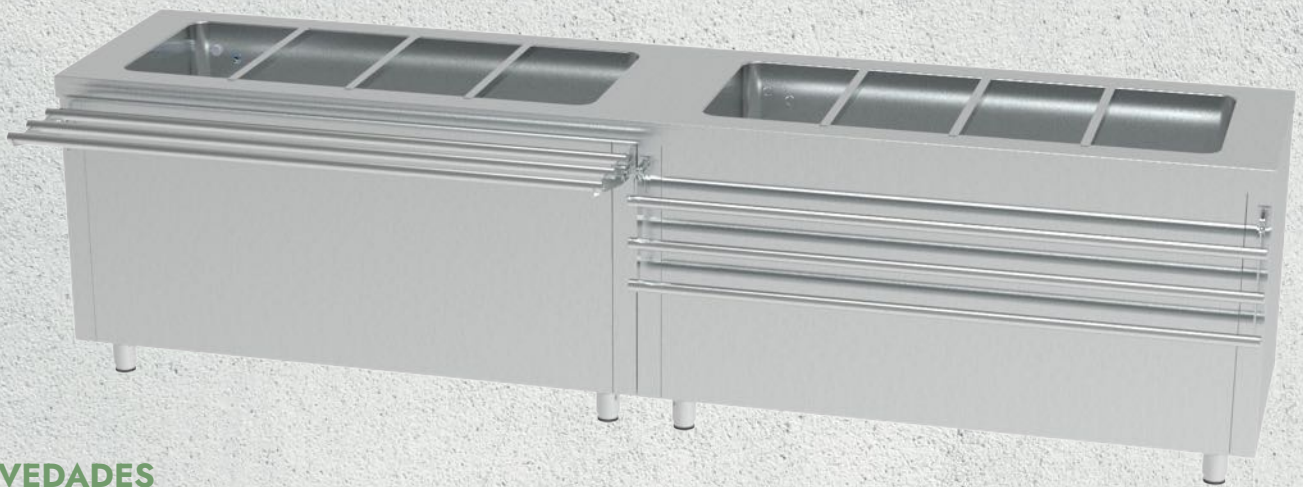

NOVEDADES

NEWS

- Fondo 700mm en lugar de 800mm.
- Altura 850mm en lugar de 900mm.
- Correbandejas abatible.
- Nueva unión de encimeras "a la testa".

- Fondo 700mm en lugar de 800mm.
- Altura 850mm en lugar de 900mm.
- Correbandejas abatible.
- Nueva unión de encimeras "a la testa".



DETALLE DE LA UNIÓN
JOINT DETAIL

CONFIGURACIÓN LINEAL SELF SERVICE

LINEAR SELF SERVICE CONFIGURATION

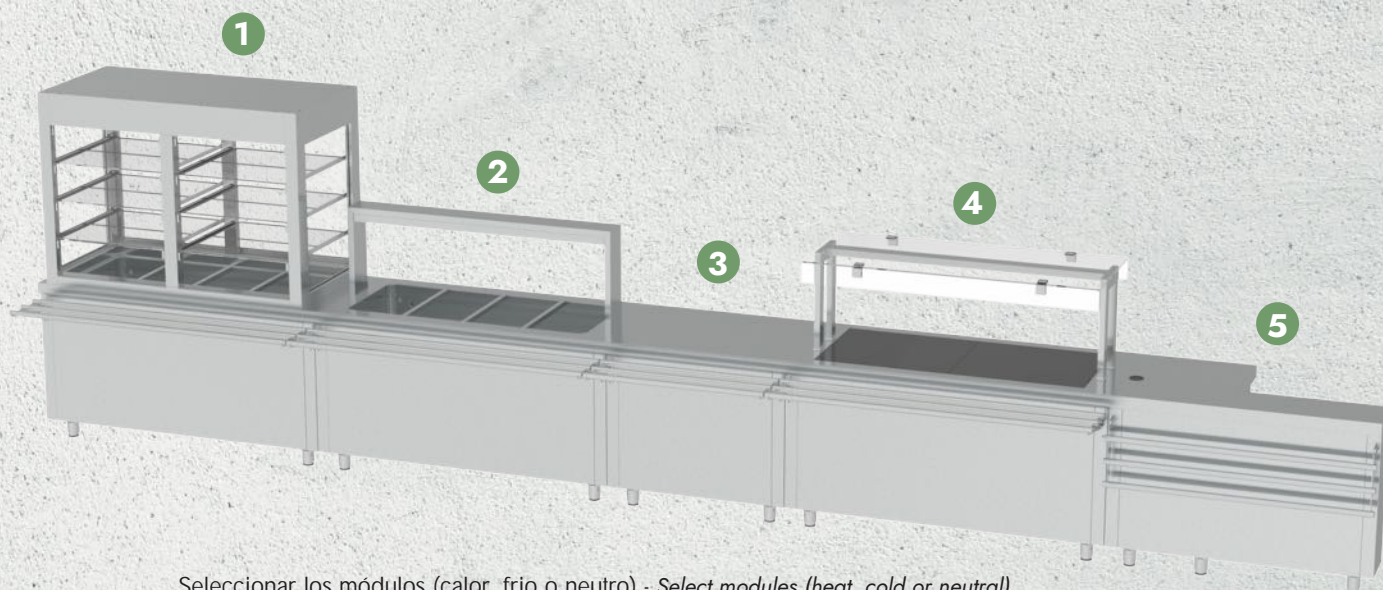

Seleccionar los módulos (calor, frío o neutro) - *Select modules (heat, cold or neutral)*

Elegir la longitud (2GN, 3GN, 4GN o 6GN) - *Choose the length (2GN, 3GN, 4GN or 6GN)*

Seleccionar los soportes con pantalla y los cristales - *Select the supports with screen and the crystals.*

EJEMPLO DE LINEAL SELF-SERVICE · LINEAR SELF-SERVICE EXAMPLE

Los lineales se configuran de izquierda a derecha y se configuran los módulos por independiente.

The linear ones are configured from left to right and the modules are configured independently.

1. SSCFAV4

- Correbandejas abatible

2. SSCFF4

- Correbandejas abatible
- Estructura nueva con iluminación: EEEBIU1500

3. SSNEA2

- Correbandejas abatible

4. SSVCC4

- Correbandejas abatible
- Soporte pantalla: EEECU1 (1 altura)
- Pantalla: EEKIU1500 (iluminación)
- Vidrio superior: EEVSU1500
- Tabica: EEVTU1500

5. SSCD

- Correbandejas abatible

1. SSCFAV4

- Folding tray rail

2. SSCFF4

- Folding tray rail
- New structure with lighting: EEEBIU1500

3. SSNEA2

- Folding tray rail

4. SSVCC4

- Folding tray rail
- Screen support: EEECU1 (1 altura)
- Screen: EEKIU1500 (lighting)
- Glass top: EEVSU1500
- Sneeze guard: EEVTU1500

5. SSCD

- Folding tray rail

Self Service Cuba Fría - Placa Fría · Series Cold Tank - Cold Plate

Modelos · Models



SSCFA3



SSCFA4

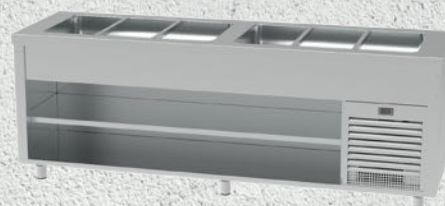

SSCFA6



SSCFF4



SSCFF6



SSPFA3



SSPFA4



SSPFA6



SSPFF4



SSPFF6



MODELO Models	PRECIO Price	MEDIDAS Measures (mm)	TEMPERATURA Temperature (°C)	CLASE CLIMÁTICA Climatic Class (°C)	RESERVA REF Cold Store (°C)	TENSIÓN FRECUENCIA Electrical data	MATERIAL Material	CUBETAS Tank	PUERTAS Doors	POTENCIA Power (W)	POTENCIA FRIG Cooling capacity (W A ·10°C)
SSCFA3	2.813 €	1240 x 700 x 850	+2°C/+10°C	4 / 38°C	-----	230V/1ph/50Hz	AISI 304	3 GN	-----	223	370
SSCFA4	3.107 €	1560 x 700 x 850	+2°C/+10°C	4 / 38°C	-----	230V/1ph/50Hz	AISI 304	4 GN	-----	223	370
SSCFA6	4.072 €	2310 x 700 x 850	+2°C/+10°C	4 / 38°C	-----	230V/1ph/50Hz	AISI 304	6 GN	-----	382	687
SSCFF4	4.333 €	1560 x 700 x 850	+2°C/+10°C	4 / 38°C	0°C/+6°C	230V/1ph/50Hz	AISI 304	4 GN	2	528	687
SSCFF6	5.237 €	2310 x 700 x 850	+2°C/+10°C	4 / 38°C	0°C/+6°C	230V/1ph/50Hz	AISI 304	6 GN	3	661	951
SSPFA3	2.762 €	1240 x 700 x 850	-4°C/+4°C	4 / 38°C	-----	230V/1ph/50Hz	AISI 304	3 GN	-----	223	370
SSPFA4	2.934 €	1560 x 700 x 850	-4°C/+4°C	4 / 38°C	-----	230V/1ph/50Hz	AISI 304	4 GN	-----	223	370
SSPFA6	3.655 €	2310 x 700 x 850	-4°C/+4°C	4 / 38°C	-----	230V/1ph/50Hz	AISI 304	6 GN	-----	382	687
SSPFF4	4.357 €	1560 x 700 x 850	-4°C/+4°C	4 / 38°C	0°C/+6°C	230V/1ph/50Hz	AISI 304	4 GN	2	528	687
SSPFF6	4.892 €	2310 x 700 x 850	-4°C/+4°C	4 / 38°C	0°C/+6°C	230V/1ph/50Hz	AISI 304	6 GN	3	661	951

REFRIGERANTE · REFRIGERANT R290

Correbandejas
opcional · *Optional*



SSCFF4



SSCFA3

Vitrina Cuba Fría - Placa Fría · Case Cold Tank - Cold Plate

Modelos · Models



SSCFAV4

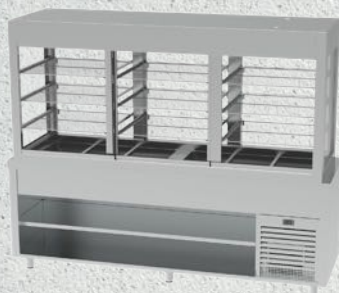

SSCFAV6



SSCFFV4

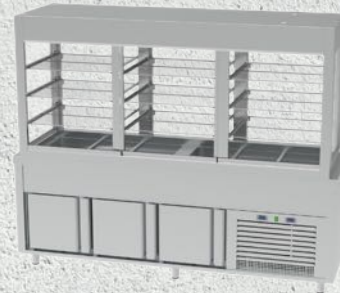

SSCFFV6



SSPFAV4

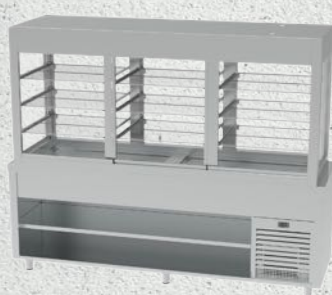

SSPFAV6

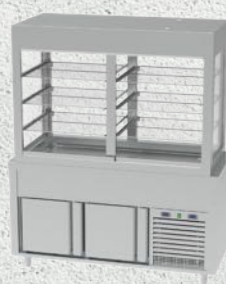

SSPFFV4

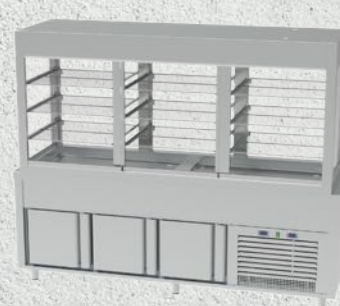

SSPFFV6



SSCFAV6



MODELO Models	PRECIO Price	MEDIDAS MEASURES (mm)	TEMPERATURA Temperature (°C)	CLASE CLIMÁTICA Climatic Class (°C)	RESERVA REFR. Cold Store (°C)	TENSIÓN -FRECUENCIA Electrical data	MATERIAL Material	CUBETA Tank	PUERTAS Doors	POTENCIA Power (W)	POTENCIA FRIG. Cooling capacity (W A -10°C)	TIPO DE ACCESO Access Type
SSCFAV4	6.235 €	1560 x 700 x 1850	Cuba Fria - Cold Tank +2°C/+10°C Vitrina - Display Cabinet +4°C/+12°C	4 / 38°C	---	230V/1ph/50Hz	AISI 304	4 GN	---	969	1048	Corredera · Aballble Sliding Door · Hinged Door
SSCFAV6	7.789 €	2310 x 700 x 1850	Cuba Fria - Cold Tank +2°C/+10°C Vitrina - Display Cabinet +4°C/+12°C	4 / 38°C	---	230V/1ph/50Hz	AISI 304	6 GN	---	1234	1425	
SSCFFV4	7.461 €	1560 x 700 x 1850	Cuba Fria - Cold Tank +2°C/+10°C Vitrina - Display Cabinet +4°C/+12°C	4 / 38°C	0°C/+6°C	230V/1ph/50Hz	AISI 304	4 GN	2	841	1041	
SSCFFV6	8.691 €	2310 x 700 x 1850	Cuba Fria - Cold Tank +2°C/+10°C Vitrina - Display Cabinet +4°C/+12°C	4 / 38°C	0°C/+6°C	230V/1ph/50Hz	AISI 304	6 GN	3	1136	1446	
SSPFAV4	6.062 €	1560 x 700 x 1850	Placa Fria - Cold Plate -4°C/+4°C Vitrina - Display Cabinet +4°C/+12°C	4 / 38°C	---	230V/1ph/50Hz	AISI 304	4 GN	---	618	951	
SSPFAV6	8.123 €	2310 x 700 x 1850	Placa Fria - Cold Plate -4°C/+4°C Vitrina - Display Cabinet +4°C/+12°C	4 / 38°C	---	230V/1ph/50Hz	AISI 304	6 GN	---	976	1446	
SSPFFV4	6.630 €	1560 x 700 x 1850	Placa Fria - Cold Plate -4°C/+4°C Vitrina - Display Cabinet +4°C/+12°C	4 / 38°C	0°C/+6°C	230V/1ph/50Hz	AISI 304	4 GN	2	724	1041	
SSPFFV6	8.499 €	2310 x 700 x 1850	Placa Fria - Cold Plate -4°C/+4°C Vitrina - Display Cabinet +4°C/+12°C	4 / 38°C	0°C/+6°C	230V/1ph/50Hz	AISI 304	6 GN	3	1004	1446	

REFRIGERANTE · REFRIGERANT **R290**



SSPFFV4

Estante de metacrilato opcional
Shelf methacrylate optional

Funcionamiento con grupo frigorífico único,
con dos circuitos independientes que permiten
desconectar una de las zonas.

Functions with a single refrigeration unit with
two separate circuits, so that one area may be
switched.

Vitrina Refrigeración 3 Niveles · Vitrina Refrigeración Abierta 3 Niveles
3 Levels Case Cold Tank · 3 Levels Open Service Refrig Case
Modelos · Models



SSVSFCG4

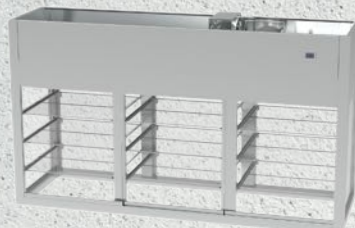

SSVSFCG6



SSVCFCG4

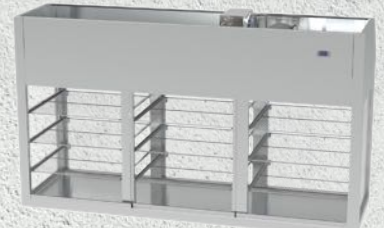

SSVCFCG6

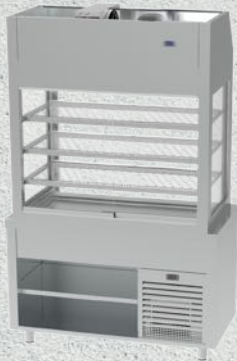

SSPFAVA3



SSPFAVA4



SSVASF3



SSVASF4



SSVSFCG4



MODELO Models	PRECIO PRICE	MEDIDAS MEASURES (mm)	TEMPERATURA TEMPERATURE (°C)	CLASE CLIMÁTICA CLIMATIC CLASS (°C)	TENSIÓN · FRECUENCIA ELECTRICAL DATA	MATERIAL MATERIAL	POTENCIA POWER (W)	POTENCIA FRIG. · COOLING CAPACITY (W A · -10°C)	TIPO DE ACCESO Access Type
SSVSFCG4	3.814 €	1450 x 700 x 1260	+4°C/+12°C	4 / 38°C	230V/1ph/50Hz	AISI 304	618	951	Corredera · Abalble Sliding Door · Hinged Door
SSVSFCG6	4.783 €	2200 x 700 x 1260	+4°C/+12°C	4 / 38°C	230V/1ph/50Hz	AISI 304	976	1446	
SSVFCG4	4.210 €	1450 x 700 x 1260	+4°C/+12°C	4 / 38°C	230V/1ph/50Hz	AISI 304	618	951	
SSVFCG6	5.124 €	2200 x 700 x 1260	+4°C/+12°C	4 / 38°C	230V/1ph/50Hz	AISI 304	976	1446	
SSPFAVA3	6.889 €	1240 x 700 x 2110	+4°C/+12°C	4 / 38°C	230V/1ph/50Hz	AISI 304	1376	2150	Corredera · Abierta* Sliding Door · Opened*
SSPFAVA4	8.171 €	1560 x 700 x 1850	+4°C/+12°C	4 / 38°C	230V/1ph/50Hz	AISI 304	1415	2150	
SSVASF3	4.154 €	1130 x 700 x 1260	+4°C/+12°C	4 / 38°C	230V/1ph/50Hz	AISI 304	1330	1805	
SSVASF4	5.266 €	1450 x 700 x 1260	+4°C/+12°C	4 / 38°C	230V/1ph/50Hz	AISI 304	1330	1805	

REFRIGERANTE · REFRIGERANT **R290**

*Con cortina nocturna · With night curtain



Tiempo servicio 2h
Service time 2h

SSPFAVA4

Baño María Reserva Caliente - Baño María Reserva Neutra
Bain Marie on heated cabinet - Bain Marie on neutral cabinet
Modelos · Models



SSBMC3



SSBMC4

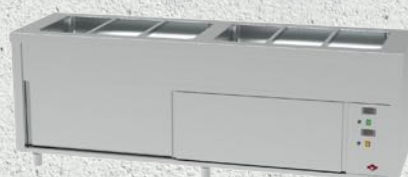

SSBMC6



SSBMA2



SSBMA3



SSBMA4



SSBMA6



SSBMN3



SSBMN4



SSBMN6



SSBMC4



MODELO Models	PRECIO Price	MEDIDAS Measures (mm)	TEMPERATURA Temperature (°C)	CLASE CLIMÁTICA Climatic class (°C)	RESERVA Cabinet (°C)	TENSIÓN -FRECUENCIA Electrical data	MATERIAL Material	CUBETA Tank	PUERTAS Doors	POTENCIA Power (W)
SSBMC3	3.270 €	1240 x 700 x 850	+30°C/+90°C	4 / 38°C	+30°C/+90°C	400V/ 3ph/ 50Hz	AISI 304	3 GN	2	3500
SSBMC4	3.821 €	1560 x 700 x 850	+30°C/+90°C	4 / 38°C	+30°C/+90°C	400V/ 3ph/ 50Hz	AISI 304	4 GN	2	4500
SSBMC6	4.989 €	2310 x 700 x 850	+30°C/+90°C	4 / 38°C	+30°C/+90°C	400V/ 3ph/ 50Hz	AISI 304	6 GN	2	6000
SSBMA2	2.338 €	910 x 700 x 850	+30°C/+90°C	4 / 38°C	—	230V/ 1ph/ 50Hz*	AISI 304	2 GN	—	1500
SSBMA3	2.697 €	1240 x 700 x 850	+30°C/+90°C	4 / 38°C	—	230V/ 1ph/ 50Hz*	AISI 304	3 GN	—	2500
SSBMA4	3.040 €	1560 x 700 x 850	+30°C/+90°C	4 / 38°C	—	400V/ 3ph/ 50Hz	AISI 304	4 GN	—	3500
SSBMA6	4.168 €	2310 x 700 x 850	+30°C/+90°C	4 / 38°C	—	400V/ 3ph/ 50Hz	AISI 304	6 GN	—	5000
SSBMN3	2.946 €	1240 x 700 x 850	+30°C/+90°C	4 / 38°C	—	230V/ 1ph/ 50Hz*	AISI 304	3 GN	2	2500
SSBMN4	3.379 €	1560 x 700 x 850	+30°C/+90°C	4 / 38°C	—	400V/ 3ph/ 50Hz	AISI 304	4 GN	2	3500
SSBMN6	4.595 €	2310 x 700 x 850	+30°C/+90°C	4 / 38°C	—	400V/ 3ph/ 50Hz	AISI 304	6 GN	2	5000

*Infrarrojos >3000W → 400V/3ph/50Hz · *Infrared >3000W → 400V/3ph/50Hz



SSBMN4

Baño María Seco Ventilado - Vitrocerámica
Ventilated Bain Marie - Glass Ceramic Hob
Modelos - Models



SSBMVA3



SSBMVA4



SSBMVC3

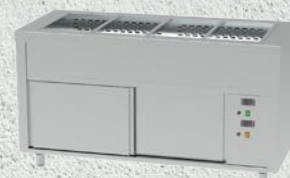

SSBMVC4



SSVCA2



SSVCA3



SSVCA4



SSVCN3



SSVCN4



SSVCC3



SSVCC4

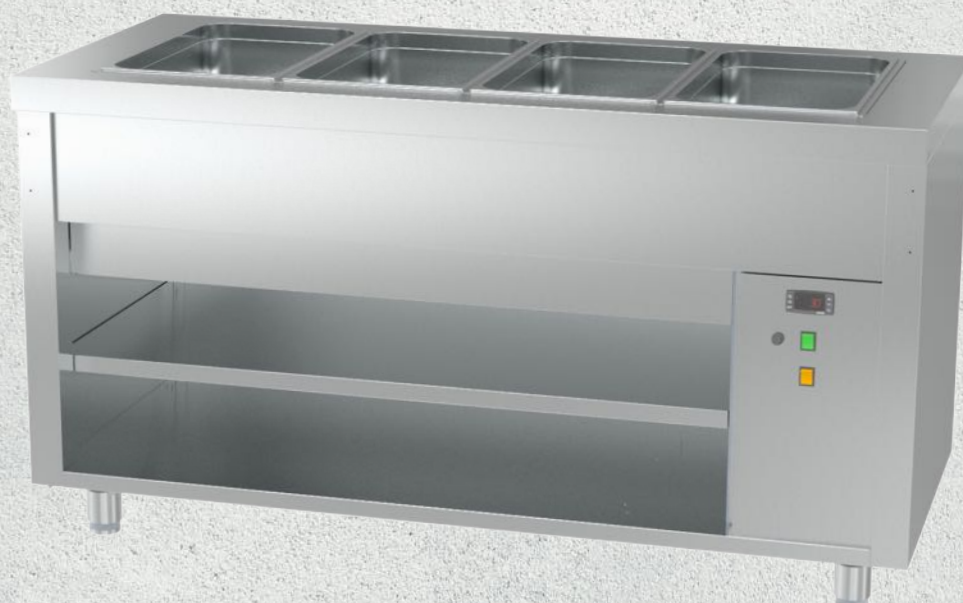

SSBMVA4



MODELO Models	PRECIO Price	MEDIDAS Measures (mm)	TEMPERATURA Temperature (°C)	CLASE CLIMÁTICA Climatic class (°C)	RESERVA Cabinet (°C)	TENSION -FRECUENCIA Electrical data	MATERIAL Material	CUBETA Tank	PUERTAS Doors	POTENCIA Power (W)
SSBMVA3	2.745 €	1240 x 700 x 850	+30°C/+90°C	4 / 38°C	—	230V/ 1ph/ 50Hz*	AISI 304	3 GN	—	2040
SSBMVA4	3.232 €	1560 x 700 x 850	+30°C/+90°C	4 / 38°C	—	400V/ 3ph/ 50Hz	AISI 304	4 GN	—	4040
SSBMVC3	3.373 €	1240 x 700 x 850	+30°C/+90°C	4 / 38°C	+30°C/+90°C	230V/ 1ph/ 50Hz*	AISI 304	3 GN	2	3060
SSBMVC4	3.836 €	1560 x 700 x 850	+30°C/+90°C	4 / 38°C	+30°C/+90°C	400V/ 3ph/ 50Hz	AISI 304	4 GN	2	5060
SSVCA2	3.311 €	910 x 700 x 850	+30°C/+90°C Max. 130°C	4 / 38°C	—	230V/ 1ph/ 50Hz*	AISI 304	—	—	900
SSVCA3	3.880 €	1240 x 700 x 850	+30°C/+90°C Max. 130°C	4 / 38°C	—	230V/ 1ph/ 50Hz*	AISI 304	—	—	1350
SSVCA4	5.103 €	1560 x 700 x 850	+30°C/+90°C Max. 130°C	4 / 38°C	—	230V/ 1ph/ 50Hz*	AISI 304	—	—	1800
SSVCN3	4.163 €	1240 x 700 x 850	+30°C/+90°C Max. 130°C	4 / 38°C	—	230V/ 1ph/ 50Hz*	AISI 304	—	2	1350
SSVCN4	5.466 €	1560 x 700 x 850	+30°C/+90°C Max. 130°C	4 / 38°C	—	230V/ 1ph/ 50Hz*	AISI 304	—	2	1800
SSVCC3	4.457 €	1240 x 700 x 850	+30°C/+90°C Max. 130°C	4 / 38°C	+30°C/+90°C	230V/ 1ph/ 50Hz*	AISI 304	—	2	2370
SSVCC4	5.758 €	1560 x 700 x 850	+30°C/+90°C Max. 130°C	4 / 38°C	+30°C/+90°C	230V/ 1ph/ 50Hz*	AISI 304	—	2	2820

*Infrarrojos >3000W → 400V/3ph/50Hz · *Infrared >3000W → 400V/3ph/50Hz

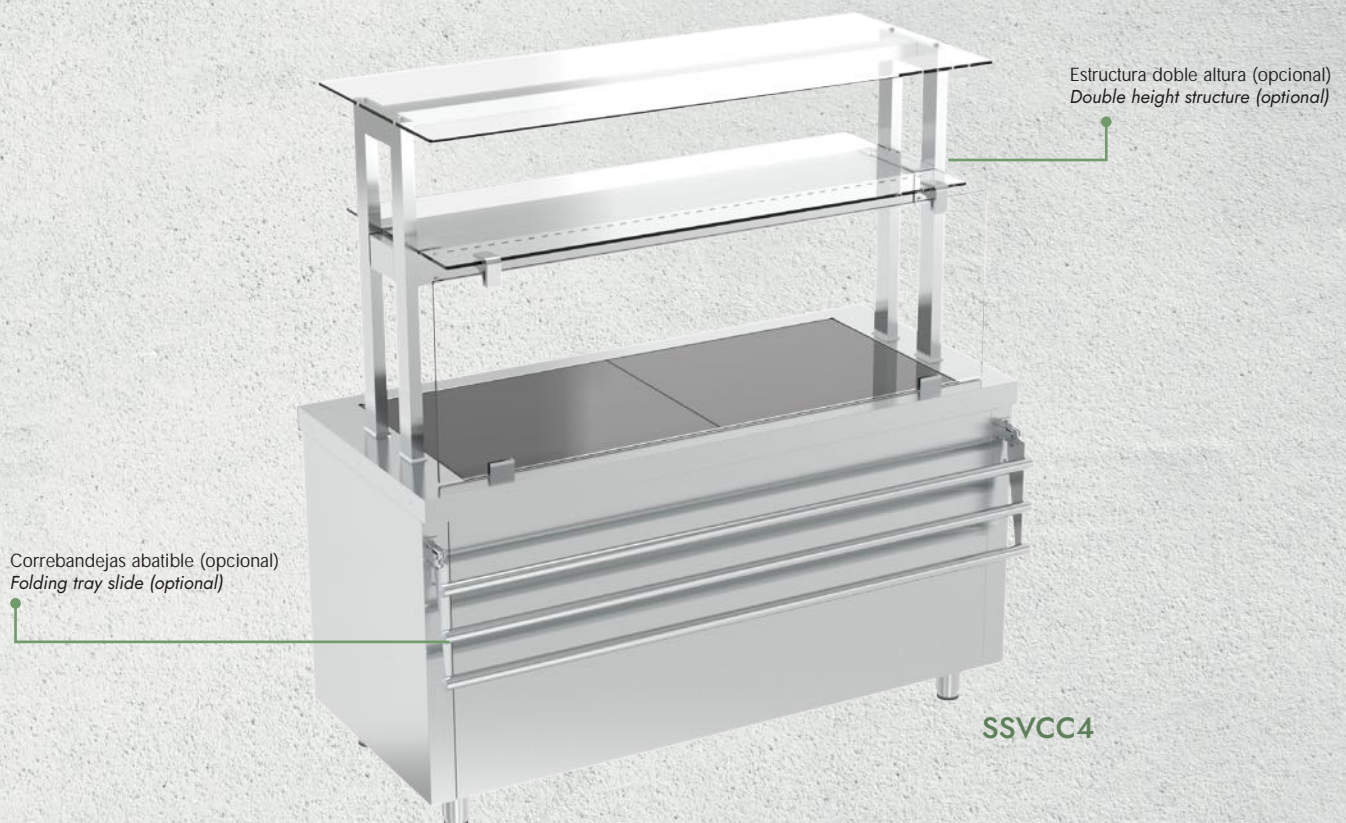

SSVCC4

Mesas Calientes - Self Neutro · Hot tables - Neutral
Modelos · Models



SSNEC3



SSNEC4

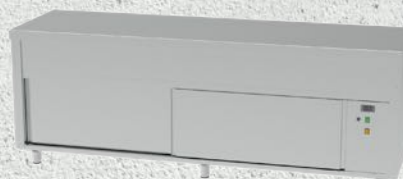

SSNEC6



SSNEA2



SSNEA3



SSNEA4

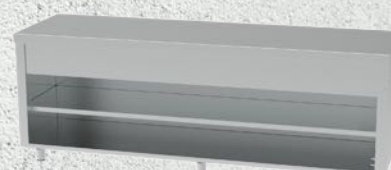

SSNEA6

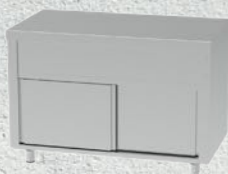

SSNEN3

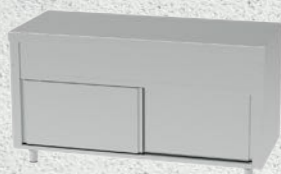

SSNEN4

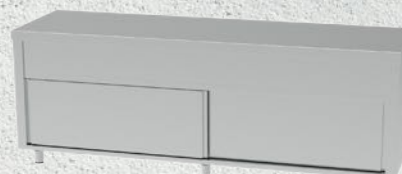

SSNEN6

SSNEA4

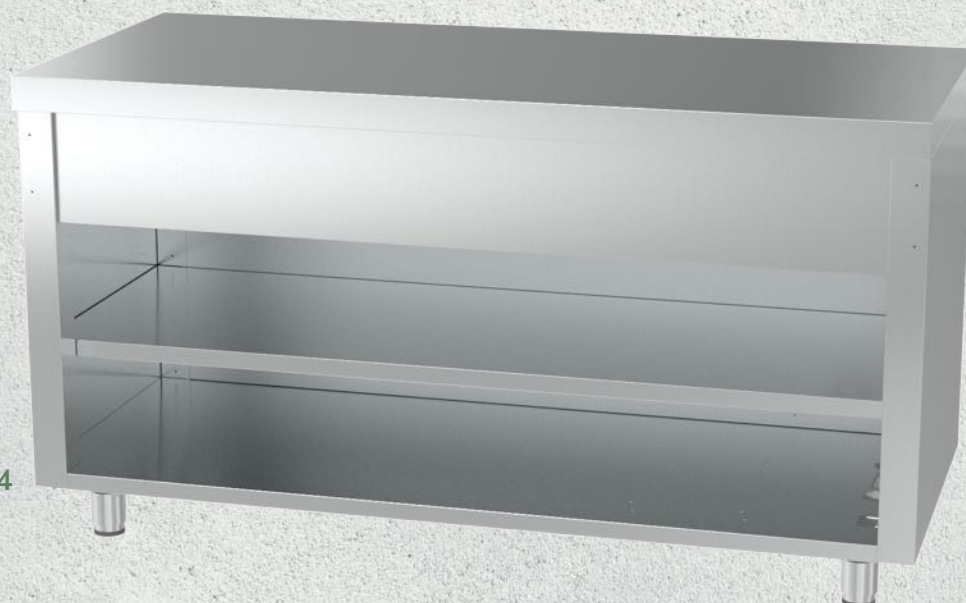



MODELO Models	PRECIO Price	MEDIDAS Measures (mm)	TEMPERATURA Temperature (°C)	CLASE CLIMÁTICA Climatic class (°C)	RESERVA Cabinet (°C)	TENSIÓN · FRECUENCIA Electrical data	MATERIAL Material	PUERTAS Doors	POTENCIA Power (W)
SSNEC3	2.372 €	1240 x 700 x 850	+30°C/+90°C	4 / 38°C	+30°C/+90°C	230V/ 1ph/ 50Hz*	AISI 304	2	1020
SSNEC4	2.650 €	1560 x 700 x 850	+30°C/+90°C	4 / 38°C	+30°C/+90°C	230V/ 1ph/ 50Hz*	AISI 304	2	1020
SSNEC6	3.381 €	2310 x 700 x 850	+30°C/+90°C	4 / 38°C	+30°C/+90°C	230V/ 1ph/ 50Hz*	AISI 304	2	1020
SSNEA2	1.127 €	910 x 700 x 850	—	—	—	—	AISI 304	—	—
SSNEA3	1.433 €	1240 x 700 x 850	—	—	—	—	AISI 304	—	—
SSNEA4	1.638 €	1560 x 700 x 850	—	—	—	—	AISI 304	—	—
SSNEA6	2.254 €	2310 x 700 x 850	—	—	—	—	AISI 304	—	—
SSNEN3	1.660 €	1240 x 700 x 850	—	—	—	—	AISI 304	2	—
SSNEN4	1.937 €	1560 x 700 x 850	—	—	—	—	AISI 304	2	—
SSNEN6	2.669 €	2310 x 700 x 850	—	—	—	—	AISI 304	2	—

*Infrarrojos >3000W → 400V/3ph/50Hz · *Infrared >3000W → 400V/3ph/50Hz



SSNEC4



SSNEN3

Elementos Neutros · Neutral Units
Modelos · Models

SELF ANGULAR · ANGULAR SELF

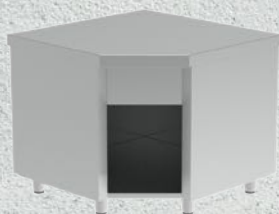

SSAA90
1002 x 1002 x 850 mm
1.492 €



SSAC90
1002 x 1002 x 850 mm
1.466 €



SSAA45
984 x 663 x 850 mm
1.074 €



SSAC45
984 x 663 x 850 mm
1.074 €

SELF CAJA · BOX SELF



SSCD
1240 x 700 x 850 mm
1.302 €

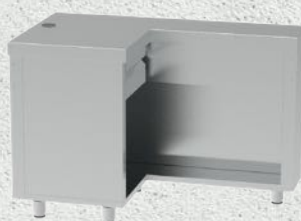

SSCI
1240 x 700 x 850 mm
1.302 €



SSNEA4
Con correbandejas
With tray slider

Elementos Neutros · Neutral Units
Modelos · Models

DISPENSADORES PLATOS · PLATE DISPENSER



SSDPNA2
910 x 700 x 850 mm
2.365 €



SSDPC2
910 x 700 x 850 mm
3.357 €

ADAPTADOR CARROS · DISPENSER TROLLEY ADAPTER



SSABA 1
910 x 700 x 850 mm
1.086 €

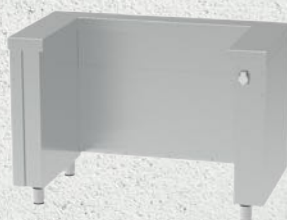

SSABA 3
1240 x 700 x 850 mm
1.225 €

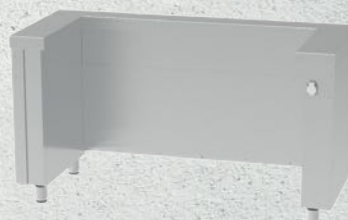

SSABA 4
1560 x 700 x 850 mm
1.467 €



SSDPNA2

Composición Conjunto Pantallas · Composition Set Screens

Dependiendo de las necesidades se pueden hacer las siguientes combinaciones para la composición de un conjunto completo:
 Depending on the requirements, these can be made the following combinations for the composition of a complete set:

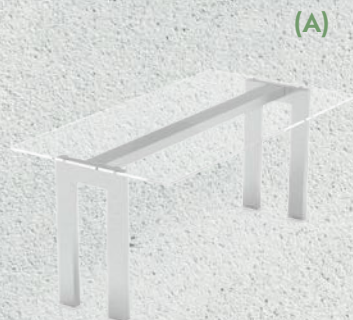

(A)

- A.**
*** Soporte 1 altura**
 - Soporte 1 altura: EEECU1
 - Pantalla ciega: EEPCU
 - Vidrio superior: EEVSU

- A.**
*** one height support**
 - Single height support: EEECU1
 - Screen: EEPCU
 - Glass top: EEVSU



(B)

- B.**
*** Soporte 1 altura**
 - Soporte 1 altura: EEECU1
 - Pantalla (ciega, iluminación, infrarrojos, iluminación+infrarrojos)
 - Vidrio superior: EEVSU
 - Vidrio frontal: EEVFU

- B.**
*** one height support**
 - Single height support: EEECU1
 - Screen (lighting+ infrared)
 - Glass top: EEVSU
 - Front glass: EEVFU



(C)

- C.**
*** Soporte 2 alturas**
 - Soporte 2 altura: EEECU2
 - Pantalla (2un) (ciega, iluminación, infrarrojos, iluminación+infrarrojos)
 - Vidrio superior: EEVSU
 - Estante cristal: EEVEU

- C.**
*** Double height support**
 - Double height support: EEECU2
 - Screen (2units) (lighting + infrared)
 - Glass top: EEVSU
 - Glass shelf: EEVEU



(D)

- D.**
*** Soporte 2 alturas + vidrio frontal**
 - Soporte 2 altura: EEECU2
 - Pantalla (2un) (ciega, iluminación, infrarrojos, iluminación+infrarrojos)
 - Vidrio superior: EEVSU
 - Estante cristal: EEVEU
 - Vidrio frontal: EEVFU

- D.**
*** Double height and front glass**
 - Double height support: EEECU2
 - Screen (2units) (lighting and infrared)
 - Top Glass: EEVSU
 - Glass shelf: EEVEU
 - Front glass: EEVFU



(E)

- E.**
*** Pantalla Nueva**
 - Con iluminación: EEEBUI

- E.**
*** New Display**
 - EEEBUI lighting



(F)

- F.**
*** Nueva estructura con vidrio superior y tabicas**
 - Con infrarrojos EEEBIRU
 - Con vidrio superior EEVSU
 - Con tabicas EEVTU

- F.**
*** New structure with top glass and dividers**
 - EEEBIRU infrared
 - EEVSU top glass
 - EEVTU dividers

Soportes para Pantallas · Screen Supports

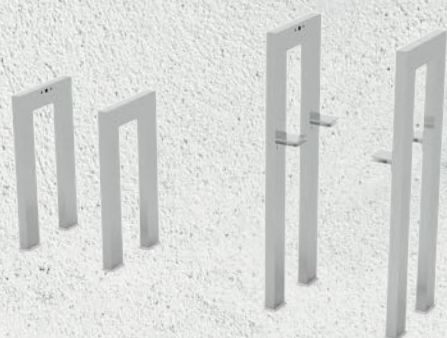

MODELO · Models	EEECU1	EEECU2
PRECIO · PRICE	292 €	572 €
ALTURA · HEIGHT (mm)	1	2
MEDIDAS · MEASURES (mm)	260 x 30 x 476	260 x 30 x 766

Tipo de Pantallas · Type of Screens



(A) Pantalla Iluminación
Lighting Screen

(A) PANTALLA ILUMINACIÓN / LIGHTING SCREEN			
MODELO · Models	EEKIU750	EEKIU1125	EEKIU1500
PRECIO · PRICE	266 €	274 €	285 €
MEDIDAS · MEASURES (mm)	710 x 74 x 36	1030 x 74 x 36	1350 x 74 x 36
Para Módulos de: For Modules of:	2GN	3GN	4GN

Módulo de 6GN = 2 x 3GN / Module of 6GN = 2 x 3GN

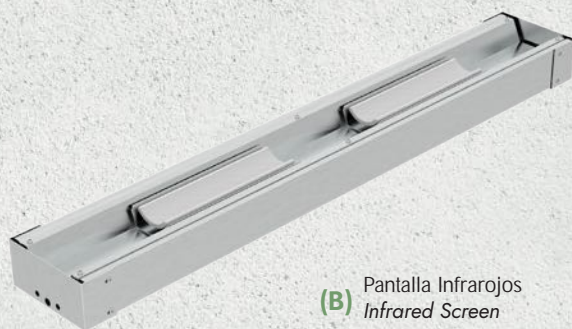

(B) Pantalla Infrarojos
Infrared Screen

(B) PANTALLA INFRAROJOS / INFRARED SCREEN			
MODELO · Models	EEKIRU750	EEKIRU1125	EEKIRU1500
PRECIO · PRICE	345 €	436 €	531 €
MEDIDAS · MEASURES (mm)	710 x 155 x 74	1030 x 155 x 74	1350 x 155 x 74
POTENCIA · POWER	500 W	1000 W	1500 W
Para Módulos de: For Modules of:	2GN	3GN	4GN

Módulo de 6GN = 2 x 3GN / Module of 6GN = 2 x 3GN



(C) Pantalla Iluminación más Infrarojos
Lighting and Infrared Screen

(C) PANTALLA ILUMINACIÓN MÁS INFRAROJOS / LIGHTING AND INFRARED SCREEN			
MODELO · Models	EEKIRLU750	EEKIRLU1125	EEKIRLU1500
PRECIO · PRICE	447 €	544 €	661 €
MEDIDAS · MEASURES (mm)	710 x 248 x 74	1030 x 248 x 74	1350 x 248 x 74
POTENCIA · POWER	500 W	1000 W	1500 W
Para Módulos de: For Modules of:	2GN	3GN	4GN

Módulo de 6GN = 2 x 3GN / Module of 6GN = 2 x 3GN



(D) Estructura Sólida
Solid Structure

(D) ESTRUCTURA SÓLIDA · SOLID STRUCTURE			
ILUMINACIÓN	EEEBIU750	EEEBIU1125	EEEBIU1500
PRECIO · PRICE	281 €	308 €	339 €
INFRAROJOS	EEEBIRU750	EEEBIRU1125	EEEBIRU1500
POTENCIA	500 W	1000 W	1500 W
PRECIO · PRICE	360 €	470 €	585 €
ILUMINACIÓN MÁS INFRAROJOS	EEEBIRLU750	EEEBIRLU1125	EEEBIRLU1500
POTENCIA	500 W	1000 W	1500 W
PRECIO · PRICE	462 €	578 €	715 €
MEDIDAS-MEASURES (mm)	772 x 151 x 475	1092 x 151 x 475	1412 x 151 x 475
PARA MÓDULOS DE	2GN	3GN	4GN

Módulo de 6GN = 2 x 3GN / Module of 6GN = 2 x 3GN



(E) Vidrio Superior
Glass Top

(E) VIDRIO SUPERIOR/GLASS TOP			
MODELO · Models	EEVSU750	EEVSU1125	EEVSU1500
PRECIO · PRICE	104 €	112 €	127 €
MEDIDAS-MEASURES (mm)	790 x 590 x 8	1110 x 590 x 8	1430 x 590 x 8
Para Módulos de: For Modules of:	2GN	3GN	4GN

Módulo de 6GN = 2 x 3GN / Module of 6GN = 2 x 3GN



(F) Estante Cristal
Glass Shelf

(F) ESTANTE CRISTAL/ GLASS SHELF			
MODELO · Models	EEVEU750	EEVEU1125	EEVEU1500
PRECIO · PRICE	85 €	97 €	114 €
MEDIDAS-MEASURES (mm)	705 x 470 x 8	1025 x 470 x 8	1345 x 470 x 8
Para Módulos de: For Modules of:	2GN	3GN	4GN

Módulo de 6GN = 2 x 3GN / Module of 6GN = 2 x 3GN

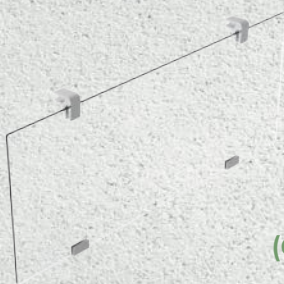

(G) Vidrio Frontal
Front Glass

(G) VIDRIO FRONTAL / FRONT GLASS			
MODELO · Models	EEVFU750	EEVFU1125	EEVFU1500
PRECIO · PRICE	210 €	224 €	236 €
MEDIDAS-MEASURES (mm)	790 x 460 x 8	1110 x 460 x 8	1430 x 460 x 8
Para Módulos de: For Modules of:	2GN	3GN	4GN

Módulo de 6GN = 2 x 3GN / Module of 6GN = 2 x 3GN



(H) Tabicas
Tabicas

(H) TÁBICAS · TÁBICAS (precio incluye 2 unidades · price includes 2 units)			
	EEVSTU750	EEVSTU1125	EEVSTU1500
Para Módulos de: For Modules of:	2GN (750)	3GN (1125)	4GN (1500)
PRECIO · PRICE	164 €	172 €	179 €
MEDIDAS-MEASURES (mm)	790 x 100 x 8	1110 x 100 x 8	1430 x 100 x 8

Módulo de 6GN = 2 x 3GN / Module of 6GN = 2 x 3GN

Guía Correbandejas · Linear tray guides

MODELO Models	CBSS2	CBSS3	CBSS4	CBSS6	CBSS45	CBSS90
PRECIO PRICE	222 €	240 €	277 €	340 €	406 €	454 €
MEDIDAS MEASURES (mm)	750 x 390 x 100	1125 x 390 x 100	1500 x 390 x 100	2250 x 390 x 100	1110 x 390 x 100	2030 x 390 x 100

Zócalos · Interior Bases

MODELO Models	ZCSS2	ZCSS3	ZCSS4	ZCSS6	ZCSSAA90T
PRECIO PRICE	108 €	126 €	151 €	184 €	165 €
MEDIDAS MEASURES (mm)	750 x 130 x 45	1125 x 130 x 45	1500 x 130 x 45	2250 x 130 x 45	610 x 130 x 45

Zócalos · Interior Bases

MODELO Models	ZCSSAC90	ZCSSAA45	ZCSSAC45	ZCSSCD	ZCSSCI	ZCLSS
PRECIO PRICE	121 €	133 €	110 €	152 €	152 €	104 €
MEDIDAS MEASURES (mm)	610 x 130 x 45	830 x 130 x 45	345 x 130 x 45	1145 x 130 x 150	1145 x 130 x 150	645 x 130 x 150

Guías lateral plato / Plate holder

MODELO Models	SSKSLP
PRECIO PRICE	306 €
MEDIDAS MEASURES (mm)	560 x 395 x 2260

Kit ruedas · Caster Kit

MODELO Models	PRECIO PRICE	UNIDADES UNITS
KR4SS	166 €	4
KR6SS	249 €	6

Serie · Series Decoración Plastificada · Plastified Decoration

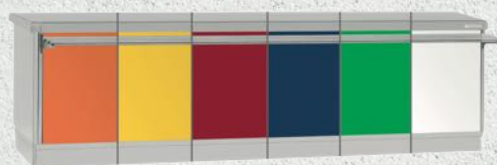

RAL 2003
Naranja
Orange

RAL 1018
Amarillo
Yellow

RAL 3003
Granate
Maroon

RAL 5017
Azul oscuro
Dark blue

RAL 6002
Verde oscuro
Dark green

RAL 9016
Blanco
White

MODELO Models	DPSS2	DPSS3	DPSS4	DPSS6	DPSSAA90	DPSSAA45	DPSSAC90	DPSSAC45
PRECIO PRICE	Sin incremento / No increase							
MEDIDAS MEASURES (mm)	750 mm	1125mm	1500 mm	2250 mm	Ángulo abierto/ Open Angle/ 90°	Ángulo abierto/ Open Angle/ 45°	Ángulo cerrado/ Closed Angle/ 90°	Ángulo cerrado/ Closed Angle/ 45°





NUEVO
NEW

BAR Station

BST1600R



Toda una estación *de servicio*

A whole service station



Bar Station · Bar Station Modelos · Models



BST1200N

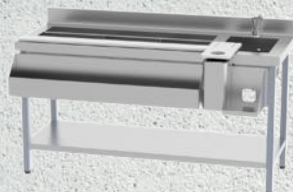

BST1600N

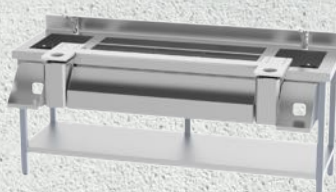

BST2000N



BST1600R

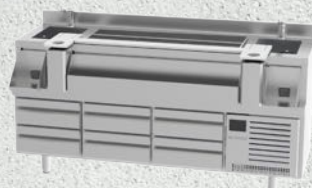

BST2000R



CONTENEDORES REFRIGERADOS: FRUTAS Y HIELOS SIEMPRE FRESCOS
REFRIGERATED CONTAINERS: FRUIT AND ICE ALWAYS FRESH

Grifos Opcionales
Optional Taps

*Difusor de agua para cocktailera
Water difuser



Contenedores para frutas refrigerados
Refrigerated Fruit organizer

Tabla de corte
Cutting board



Contenedores de hielo refrigerados
Refrigerated Ice tray

Carril para botellas
Speed Rack

BTS1600R

Refrigerada
Refrigerated

Cajones refrigerados
Refrigerated drawers

Etante para batidora
Blender station

*Cuidado con su uso para vasos
Careful with its use for glasses

MODELO Models	BST1200N	BST1600N	BST2000N	BST1600R	BST2000R
PRECIO Precio	1.939 €	2.319 €	3.243 €	5.591 €	6.981 €
MEDIDAS EXTERIORES Overall dimensions (mm)	1200 x 600 x 944	1600 x 600 x 944	2000 x 600 x 944	1600 x 700 x 1059	2000 x 700 x 1059
PESO NETO Net Weight (Kg)	78	93	107	205	242
RANGO T° Precio	-----	-----	-----	2°C / +8°C	2°C / +8°C
MATERIAL Material	Acero inoxidable AISI 304 · AISI 304 Stainless Steel				
TIPO AISLAMIENTO Insulation	Poliuretano con densidad 40kg/m3, libre CFCs, cero ODP y bajo GWP Polyurethane with high density 40kg/m3, CFCs free, zero ODP and low GWP				
CUBA PARA HIELO Ice Tank	Inyectada Injected		Inyectada y refrigerada Injected and refrigerated		
CONTROLADOR Thermostat	-----	-----	-----	Táctil, IP65 Touch-screen, IP65	Táctil, IP65 Touch-screen, IP65
SISTEMA DE FRÍO Refrigeration system	-----	-----	-----	Monoblock	Monoblock
DESESCARCHE Defrost	-----	-----	-----	Parada de compresor Compressor off	Parada de compresor Compressor off
SISTEMA DE CONDENSACIÓN Condensation	-----	-----	-----	Forzada Forced-air	Forzada Forced-air
SISTEMA DE EVAPORACIÓN Evaporation	-----	-----	-----	Evaporación con aire forzado, evaporador tratado con epoxi de poliéster anticorrosión Forced-air evaporator with anti corrosion epoxy coating	
TENSIÓN/FASES/FRECUENCIA Power Supply / Tension	-----	-----	-----	230V / 1 / 50 Hz	230V / 1 / 50 Hz
POTENCIA FRIGORÍFICA Refrigeration Capacity (W)	-----	-----	-----	370	370
POTENCIA Power (W)	-----	-----	-----	209	209
CONSUMO Energy Consumption (kWh/24h)	-----	-----	-----	1,61	1,61
BANDEJA EVAPORATIVA Condensate pan	Bandeja con serpentín embutido Pan with pressed serpentín				
MEDIDAS PALETIZACIÓN Crated dimensions (mm)	1320 x 720 x 1064	1720 x 720 x 1064	2120 x 720 x 1064	1720 x 720 x 1179	2120 x 720 x 1179
VOLUMEN BRUTO Crated volume (l)	679	906	1132	1186	1482
PESO PALETIZACIÓN Crated Weight (Kg)	106	122	139	239	278

OPCIONALES · OPTIONALS:Ruedas - *Wheels*

· Mesa neutra : Consultar

· Mesa refrigerada : **169 €**Cubetas 1/9 · *Trays 1/9*· Encimera 1200: **142 €**· Encimera 1600/2000: **212 €**Doble carril de botellas · *Double rail for bottles*· Encimera 1200: **157 €**· Encimera 1600/2000: **182 €**

06. C.A.R.



HT4021

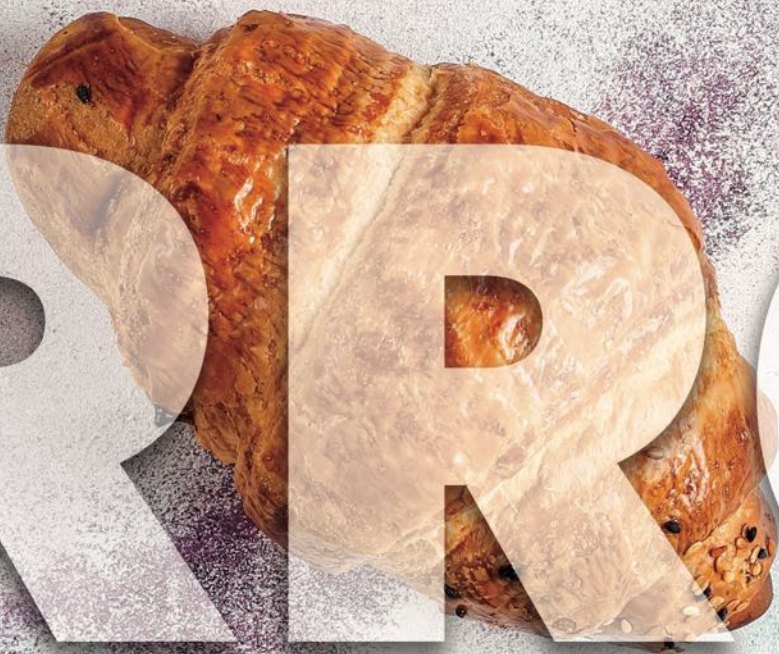

Calientes y fríos



Listos para el uso
que desees
Ready for the use you want



Carro Caliente con Puerta en Acero · Heated Banquet Trolley

Modelos · Models



CARRO CALIENTE
5 GN 2/1
HEATED BANQUET TROLLEY
5 GN 2/1

HT1021



CARRO CALIENTE
11 GN 2/1
HEATED BANQUET TROLLEY
11 GN 2/1

HT2021



CARRO CALIENTE
11+11 GN 2/1
HEATED BANQUET TROLLEY
11+11 GN 2/1

HT4021



MODELO Models	PRECIO PRICE	MEDIDAS Measures (mm)	TEMPERATURA Temperature (°C)	TENSIÓN -FRECUENCIA Electrical data	CAPACIDAD capacity	PUERTAS Doors	Nº PARRILLAS J. GUIAS N oshelves / slides	SEPARACIÓN ENTRE BANDEJAS Separation between trays	POTENCIA Power (W)
HT1021	2.417 €	910 x 827 x 1160	+50°C a +80°C	230V/50-60Hz	310L	1 puerta abatible apertura 270° / Ciega	10 GN 2/1 / 20 GN 1/1	57mm	2000
HT2021	2.947 €	910 x 827 x 1816	+50°C a +80°C	230V/50-60Hz	550L	1 puerta abatible apertura 270° / Ciega	22 GN 2/1 / 44 GN 1/1	57mm	2000
HT4021	4.976 €	910 x 1517 x 1816	+50°C a +80°C	230V/50-60Hz	1300L	1 puerta abatible apertura 270° / Ciega	22+22 GN 2/1 / 44 + 44 GN 1/1	57mm	2000



HT4021

Carro Caliente con Aporte de Humedad · Heated Banquet Trolley With Steam

Modelos · Models



CARRO CALIENTE 2/1
CON HUMIDIFICADOR
10 GN 2/1

GN 2/1 HOT BANQUET
WITH STEAM
10 GN 2/1

HT1021H



CARRO CALIENTE 2/1 CON
HUMIDIFICADOR
20 GN 2/1

GN 2/1 HOT BANQUET WITH
STEAM
20 GN 2/1

HT2021H



MODELO Models	PRECIO Price	MEDIDAS Measures (mm)	TEMPERATURA Temperature (°C)	TENSIÓN ·FRECUENCIA Electrical data	PUERTAS Doors	Nº PARRILLAS J. GUÍAS N Oshelves / Slides	SEPARACIÓN ENTRE BANDEJAS Separation Between Trays	POTENCIA Power (W)
HT1021H	3.181 €	570x879x1114	+30°C a +85°C	230V/50-60Hz	1 puerta abatible apertura 270° / Ciega	10 GN 2/1	71mm	1500
HT2021H	3.988 €	570x879x1824	+30°C a +85°C	230V/50-60Hz	1 puerta abatible apertura 270° / Ciega	20 GN 2/1	71mm	3000

* Sin control de humedad. Aporte de humedad con regulador de 1 a 5 niveles.



HT2021H

Carro Frío · Cold Banquet Trolley

Modelos · Models



CARRO FRÍO
COLD BANQUET TROLLEY
CT2021



CARRO FRÍO
15 GN 1/1'
COLD BANQUET TROLLEY
15 GN 1/1'
CT1511



CARRO FRÍO
15 GN 2/1'
COLD BANQUET TROLLEY
15 GN 1/1'
CT1521



MODELO Models	PRECIO PRICE	MEDIDAS Measures (mm)	TEMPERATURA Temperature (°C)	TENSIÓN FRECUENCIA Electrical data	CAPACIDAD capacity	PUERTAS Doors	Nº PARRILLAS J. GUÍAS N oshelves / slides	SEPARACIÓN ENTRE BANDEJAS Separation between trays	POTENCIA Power (W)
CT2021	3.400 €	910 x 850 x 1816	-2°C a +8°C	230V/50-60Hz	500 L	1 puerta abatible ciega	20GN 2/1	71mm	310
CT1511	3.942 €	570 x 880 x 1750	0°C a +10°C	230V/50-60Hz	225 L	1 puerta abatible ciega	15 GN 1/1	71mm	230
CT1521	4.540 €	775 x 1000 x 1755	0°C a +10°C	230V/50-60Hz	440 L	1 puerta abatible ciega	15 GN 2/1	71mm	250



CT2021

Carro Mixto · Hot And Cold Banquet Trolley Modelos · Models



CARRO MIXTO FRÍO Y CALIENTE
HOT AND COLD BANQUET TROLLEY
MXT1511



MODELO Models	PRECIO PRICE	MEDIDAS Measures (mm)	TEMPERATURA Temperature (°C)	TENSIÓN -FRECUENCIA Electrical data	CAPACIDAD capacity	PUERTAS Doors	Nº PARRILLAS J. GUÍAS N oshelves / slides	SEPARACIÓN ENTRE BANDEJAS Separation between trays	POTENCIA Power (W)
MXT1511	5.338 €	570x893x1749 mm	0°C a +85°C	230V/50-60Hz	225L	1 puerta abatible ciega	15 GN 1/1	71mm	1.850



MXT1511

Carro Caliente Plato Nivel Constante · Plate Dispenser Heated

Modelos · Models



DISPENSADOR DE PLATO
NIVEL CONTINUO
(40 PLATOS) CALIENTE

PLATE DISPENSER
HEATED (40 PLATE) ELEC.

HPT40



DISPENSADOR DE PLATO
NIVEL CONTINUO
(80 PLATOS) CALIENTE

PLATE DISPENSER
HEATED (80 PLATE) ELEC.

HPT80



DISPENSADOR DE PLATO
NIVEL CONTINUO
(40 PLATOS) NEUTRO

PLATE DISPENSER
NEUTRAL (40 PLATE)

NPT40



DISPENSADOR DE PLATO
NIVEL CONTINUO
(80 PLATOS) NEUTRO

PLATE DISPENSER
NEUTRAL (80 PLATE)

NPT80



MODELO Models	PRECIO Price	MEDIDAS Measures (mm)	TEMPERATURA Temperature (°C)	TENSION -FRECUENCIA Electrical data	CAPACIDAD DE PLATOS Plate capacity	PUERTAS Doors	Nº PARRILLAS J. GUÍAS N oshelves / slides	SEPARACIÓN ENTRE BANDEJAS Separation between trays	POTENCIA Power (W)
HPT40	1.057 €	440 x 440 x 850	+30°C a +90°C	230V/50-60Hz	40 Platos	un depósito		Diámetro de platos de 26 a 32	1500
HPT80	1.473 €	440 x 780 x 850	+30°C a +90°C	230V/50-60Hz	80 Platos (40+40)	dos depósitos		Diámetro de platos de 26 a 32	3000
NPT40	701 €	440 x 440 x 851			40 Platos	un depósito	GN 2/1	Diámetro de platos de 26 a 32	
NPT80	1.035 €	440 x 780 x 851			80 Platos (40+40)	dos depósitos	15 GN 1/1	Diámetro de platos de 26 a 32	



HPT80

Dispensador de Plato Nivel Constante Encastrable · Plate Dispenser Encastrable

Modelos · Models



DISPENSADOR ENCASTRABLE PLATOS NIVEL CONTINUO (40 PLATOS) CALIENTE

PLATE DISPENSER ENCASTRABLE CART HEATER (40 PLATES)

EHPT40



DISPENSADOR ENCASTRABLE PLATOS NIVEL CONTINUO (40 PLATOS) NEUTRO

PLATE DISPENSER ENCASTRABLE CART NEUTRAL (40 PLATES)

ENPT40



MODELO Models	PRECIO Price	MEDIDAS Measures (mm)	TEMPERATURA Temperature (°C)	TENSIÓN ·FRECUENCIA Electrical data	CAPACIDAD DE PLATOS Plate capacity	PUERTAS Doors	SEPARACIÓN ENTRE BANDEJAS Separation between trays	POTENCIA Power (W)
EHPT40	525 €	diámetro 430 x 850 alto	+30°C a +90°C	230V/50-60Hz	40 Platos	un depósito	Diámetro de platos de 26 a 32	1500
ENPT40	445 €	diámetro 430 x 850 alto			40 Platos	un depósito	Diámetro de platos de 26 a 32	



EHPT40

Carros para Bandejas · Trolley

Modelos · Models

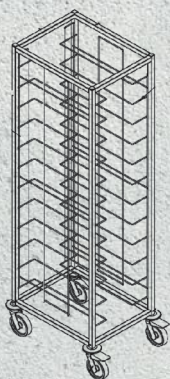

CBA12P

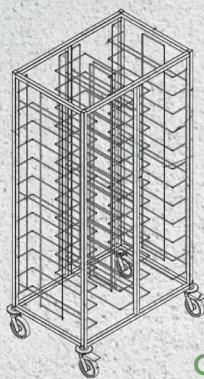

CBA24P

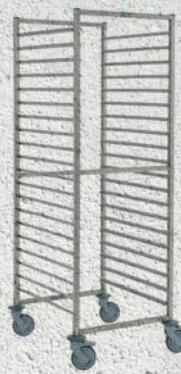

CBGN 2021
CBGN 2011



MODELO Models	PRECIO Price	MEDIDAS Measures (mm)	MATERIAL Material (°C)
CBA12P	1.140 €	510 x 633 x 1787	AISI 304
CBA24P	1.586 €	925 x 633 x 1787	AISI 304
CBGN 2011	656 €	455 x 635 x 1787	AISI 304
CBGN 2021	782 €	660 x 755 x 1787	AISI 304



CBGN 2021
CBGN 2011



07.

NEUT



Elementos NEUTROS

NE15M60809I2



Múltiples
soluciones

Multiple solutions



Mueble con Estantes Pasantes Cabinet with shelves Pass-through

ALTURA 850mm

GAMA 600



MEDIDAS (MM) MEASURES	CON ENCIMERA SIN PETO WITH WORKTOP WITHOUT SPLASH BACK		SIN ENCIMERA WITHOUT WORKTOP	
	MODELO MODEL	PRECIO PRICE €	MODELO MODEL	PRECIO PRICE €
600x600x850	NE60M60801N1	647	NE60M60801N0	497
800x600x850	NE80M60801N1	710	NE80M60801N0	538
1000x600x850	NE10M60801N1	773	NE10M60801N0	579
1200x600x850	NE12M60801N1	841	NE12M60801N0	623
1400x600x850	NE14M60801N1	904	NE14M60801N0	663
1500x600x850	NE15M60801N1	940	NE15M60801N0	688
1600x600x850	NE16M60801N1	981	NE16M60801N0	716
1800x600x850	NE18M60801N1	1.044	NE18M60801N0	757
2000x600x850	NE20M60801N1	1.132	NE20M60801N0	822
2200x600x850	NE22M60801N1	1.197	NE22M60801N0	863
2400x600x850	NE24M60801N1	1.270	NE24M60801N0	914

CON ENCIMERA SIN PETO



NE15M60801N1

GAMA 700



MEDIDAS (MM) MEASURES	CON ENCIMERA SIN PETO WITH WORKTOP WITHOUT SPLASH BACK		SIN ENCIMERA WITHOUT WORKTOP	
	MODELO MODEL	PRECIO PRICE €	MODELO MODEL	PRECIO PRICE €
600x700x850	NE60M70801N1	690	NE60M70801N0	531
800x700x850	NE80M70801N1	760	NE80M70801N0	576
1000x700x850	NE10M70801N1	830	NE10M70801N0	621
1200x700x850	NE12M70801N1	905	NE12M70801N0	668
1400x700x850	NE14M70801N1	975	NE14M70801N0	714
1500x700x850	NE15M70801N1	1.014	NE15M70801N0	741
1600x700x850	NE16M70801N1	1.058	NE16M70801N0	770
1800x700x850	NE18M70801N1	1.129	NE18M70801N0	815
2000x700x850	NE20M70801N1	1.223	NE20M70801N0	885
2200x700x850	NE22M70801N1	1.296	NE22M70801N0	930
2400x700x850	NE24M70801N1	1.376	NE24M70801N0	985

SIN ENCIMERA



NE15M60801N0

Mueble con Estantes Pasantes Cabinet with shelves Pass-through

ALTURA 600mm

GAMA 600



MEDIDAS (MM) MEASURES	CON ENCIMERA SIN PETO WITH WORKTOP WITHOUT SPLASH BACK		SIN ENCIMERA WITHOUT WORKTOP	
	MODELO MODEL	PRECIO PRICE €	MODELO MODEL	PRECIO PRICE €
600x600x600	NE60M60601N1	560	NE60M60601N0	410
800x600x600	NE80M60601N1	611	NE80M60601N0	439
1000x600x600	NE10M60601N1	662	NE10M60601N0	468
1200x600x600	NE12M60601N1	718	NE12M60601N0	499
1400x600x600	NE14M60601N1	769	NE14M60601N0	528
1500x600x600	NE15M60601N1	799	NE15M60601N0	547
1600x600x600	NE16M60601N1	834	NE16M60601N0	569
1800x600x600	NE18M60601N1	885	NE18M60601N0	597
2000x600x600	NE20M60601N1	960	NE20M60601N0	650
2200x600x600	NE22M60601N1	1.014	NE22M60601N0	679
2400x600x600	NE24M60601N1	1.075	NE24M60601N0	718

CON ENCIMERA SIN PETO



NE15M60601N1

GAMA 700



MEDIDAS (MM) MEASURES	CON ENCIMERA SIN PETO WITH WORKTOP WITHOUT SPLASH BACK		SIN ENCIMERA WITHOUT WORKTOP	
	MODELO MODEL	PRECIO PRICE €	MODELO MODEL	PRECIO PRICE €
600x700x600	NE60M70601N1	591	NE60M70601N0	431
800x700x600	NE80M70601N1	647	NE80M70601N0	463
1000x700x600	NE10M70601N1	703	NE10M70601N0	494
1200x700x600	NE12M70601N1	764	NE12M70601N0	527
1400x700x600	NE14M70601N1	820	NE14M70601N0	559
1500x700x600	NE15M70601N1	853	NE15M70601N0	579
1600x700x600	NE16M70601N1	890	NE16M70601N0	601
1800x700x600	NE18M70601N1	946	NE18M70601N0	632
2000x700x600	NE20M70601N1	1.027	NE20M70601N0	688
2200x700x600	NE22M70601N1	1.085	NE22M70601N0	720
2400x700x600	NE24M70601N1	1.152	NE24M70601N0	761

SIN ENCIMERA



NE15M60601N0

Mueble con Estantes (con trasera) Cabinet with shelves (with rear panel)

ALTURA 850mm

GAMA 600



CON ENCIMERA CON PETO



NE15M60803N2

CON ENCIMERA SIN PETO

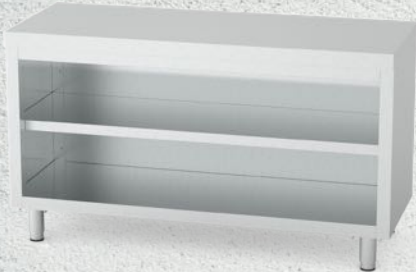

NE15M60803N1

SIN ENCIMERA



NE15M60803N0

MEDIDAS (MM) MEASURES	CON ENCIMERA CON PETO		CON ENCIMERA SIN PETO		SIN ENCIMERA	
	MODELO MODEL	PRECIO PRICE €	MODELO MODEL	PRECIO PRICE €	MODELO MODEL	PRECIO PRICE €
600x600x850	NE60M60803N2	764	NE60M60803N1	703	NE60M60803N0	554
800x600x850	NE80M60803N2	848	NE80M60803N1	783	NE80M60803N0	611
1000x600x850	NE10M60803N2	931	NE10M60803N1	862	NE10M60803N0	668
1200x600x850	NE12M60803N2	1.019	NE12M60803N1	946	NE12M60803N0	728
1400x600x850	NE14M60803N2	1.103	NE14M60803N1	1.026	NE14M60803N0	785
1500x600x850	NE15M60803N2	1.149	NE15M60803N1	1.070	NE15M60803N0	818
1600x600x850	NE16M60803N2	1.200	NE16M60803N1	1.119	NE16M60803N0	853
1800x600x850	NE18M60803N2	1.284	NE18M60803N1	1.198	NE18M60803N0	911
2000x600x850	NE20M60803N2	1.392	NE20M60803N1	1.302	NE20M60803N0	992
2200x600x850	NE22M60803N2	1.478	NE22M60803N1	1.384	NE22M60803N0	1.049
2400x600x850	NE24M60803N2	1.571	NE24M60803N1	1.473	NE24M60803N0	1.116

GAMA 700



MEDIDAS (MM) MEASURES	CON ENCIMERA CON PETO		CON ENCIMERA SIN PETO		SIN ENCIMERA	
	MODELO MODEL	PRECIO PRICE €	MODELO MODEL	PRECIO PRICE €	MODELO MODEL	PRECIO PRICE €
600x700x850	NE60M70803N2	807	NE60M70803N1	747	NE60M70803N0	587
800x700x850	NE80M70803N2	897	NE80M70803N1	833	NE80M70803N0	649
1000x700x850	NE10M70803N2	987	NE10M70803N1	919	NE10M70803N0	710
1200x700x850	NE12M70803N2	1.082	NE12M70803N1	1.010	NE12M70803N0	774
1400x700x850	NE14M70803N2	1.173	NE14M70803N1	1.096	NE14M70803N0	835
1500x700x850	NE15M70803N2	1.222	NE15M70803N1	1.144	NE15M70803N0	870
1600x700x850	NE16M70803N2	1.276	NE16M70803N1	1.196	NE16M70803N0	908
1800x700x850	NE18M70803N2	1.367	NE18M70803N1	1.283	NE18M70803N0	969
2000x700x850	NE20M70803N2	1.482	NE20M70803N1	1.393	NE20M70803N0	1.055
2200x700x850	NE22M70803N2	1.574	NE22M70803N1	1.482	NE22M70803N0	1.116
2400x700x850	NE24M70803N2	1.675	NE24M70803N1	1.579	NE24M70803N0	1.188

Mueble con Estantes (con trasera) Cabinet with shelves (with rear panel)

ALTURA 600mm

GAMA 600



CON ENCIMERA CON PETO



NE15M60603N2

CON ENCIMERA SIN PETO



NE15M60603N1

SIN ENCIMERA



NE15M60603N0

MEDIDAS (MM) MEASURES	CON ENCIMERA CON PETO WITH WORKTOP WITH SPLASH BACK		CON ENCIMERA SIN PETO WITH WORKTOP WITHOUT SPLASH BACK		SIN ENCIMERA WITHOUT WORKTOP	
	MODELO MODEL	PRECIO PRICE €	MODELO MODEL	PRECIO PRICE €	MODELO MODEL	PRECIO PRICE €
600x600x600	NE60M60603N2	661	NE60M60803N1	600	NE60M60803N0	451
800x600x600	NE80M60603N2	727	NE80M60603N1	662	NE80M60603N0	490
1000x600x600	NE10M60603N2	792	NE10M60603N1	723	NE10M60603N0	530
1200x600x600	NE12M60603N2	863	NE12M60603N1	790	NE12M60603N0	571
1400x600x600	NE14M60603N2	929	NE14M60603N1	851	NE14M60603N0	611
1500x600x600	NE15M60603N2	966	NE15M60603N1	887	NE15M60603N0	635
1600x600x600	NE16M60603N2	1.008	NE16M60603N1	927	NE16M60603N0	661
1800x600x600	NE18M60603N2	1.074	NE18M60603N1	988	NE18M60603N0	701
2000x600x600	NE20M60603N2	1.164	NE20M60603N1	1.074	NE20M60603N0	764
2200x600x600	NE22M60603N2	1.232	NE22M60603N1	1.138	NE22M60603N0	804
2400x600x600	NE24M60603N2	1.308	NE24M60603N1	1.210	NE24M60603N0	853

GAMA 700



MEDIDAS (MM) MEASURES	CON ENCIMERA CON PETO WITH WORKTOP WITH SPLASH BACK		CON ENCIMERA SIN PETO WITH WORKTOP WITHOUT SPLASH BACK		SIN ENCIMERA WITHOUT WORKTOP	
	MODELO MODEL	PRECIO PRICE €	MODELO MODEL	PRECIO PRICE €	MODELO MODEL	PRECIO PRICE €
600x700x600	NE60M70603N2	691	NE60M70603N1	631	NE60M70603N0	472
800x700x600	NE80M70603N2	762	NE80M70603N1	698	NE80M70603N0	514
1000x700x600	NE10M70603N2	833	NE10M70603N1	764	NE10M70603N0	555
1200x700x600	NE12M70603N2	908	NE12M70603N1	836	NE12M70603N0	599
1400x700x600	NE14M70603N2	978	NE14M70603N1	902	NE14M70603N0	641
1500x700x600	NE15M70603N2	1.018	NE15M70603N1	940	NE15M70603N0	666
1600x700x600	NE16M70603N2	1.063	NE16M70603N1	982	NE16M70603N0	694
1800x700x600	NE18M70603N2	1.133	NE18M70603N1	1.049	NE18M70603N0	736
2000x700x600	NE20M70603N2	1.229	NE20M70603N1	1.140	NE20M70603N0	802
2200x700x600	NE22M70603N2	1.302	NE22M70603N1	1.209	NE22M70603N0	844
2400x700x600	NE24M70603N2	1.382	NE24M70603N1	1.286	NE24M70603N0	896

Mueble con Puertas Correderas Pasantes

Cabinet with sliding doors Pass-through

ALTURA 850mm

CON ENCIMERA SIN PETO

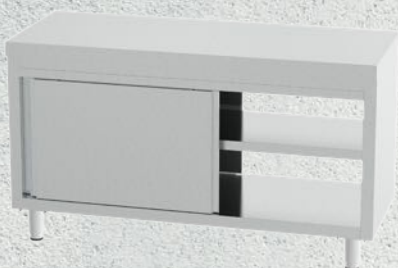

NE15M60802N1

GAMA 600



	CON ENCIMERA SIN PETO		SIN ENCIMERA	
	WITH WORKTOP WITHOUT SPLASH BACK		WITHOUT WORKTOP	
MEDIDAS (MM) MEASURES	MODELO MODEL	PRECIO PRICE €	MODELO MODEL	PRECIO PRICE €
1000x600x850	NE10M60802N1	1.202	NE10M60802N0	1.008
1200x600x850	NE12M60802N1	1.318	NE12M60802N0	1.100
1400x600x850	NE14M60802N1	1.430	NE14M60802N0	1.190
1500x600x850	NE15M60802N1	1.491	NE15M60802N0	1.239
1600x600x850	NE16M60802N1	1.556	NE16M60802N0	1.290
1800x600x850	NE18M60802N1	1.668	NE18M60802N0	1.380
2000x600x850	NE20M60802N1	1.804	NE20M60802N0	1.494
2200x600x850	NE22M60802N1	1.918	NE22M60802N0	1.583
2400x600x850	NE24M60802N1	2.040	NE24M60802N0	1.683

SIN ENCIMERA

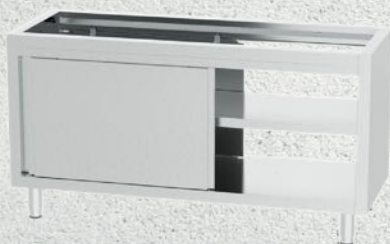

NE15M60802N0

GAMA 700



	CON ENCIMERA SIN PETO		SIN ENCIMERA	
	WITH WORKTOP WITHOUT SPLASH BACK		WITHOUT WORKTOP	
MEDIDAS (MM) MEASURES	MODELO MODEL	PRECIO PRICE €	MODELO MODEL	PRECIO PRICE €
1000x700x850	NE10M70802N1	1.259	NE10M70802N0	1.050
1200x700x850	NE12M70802N1	1.382	NE12M70802N0	1.146
1400x700x850	NE14M70802N1	1.501	NE14M70802N0	1.240
1500x700x850	NE15M70802N1	1.565	NE15M70802N0	1.291
1600x700x850	NE16M70802N1	1.633	NE16M70802N0	1.345
1800x700x850	NE18M70802N1	1.752	NE18M70802N0	1.438
2000x700x850	NE20M70802N1	1.895	NE20M70802N0	1.557
2200x600x850	NE22M70802N1	2.016	NE22M70802N0	1.651
2400x600x850	NE24M70802N1	2.145	NE24M70802N0	1.755

Mueble con Puertas Correderas Pasantes Cabinet with sliding doors Pass-through

ALTURA 600mm

GAMA 600



CON ENCIMERA SIN PETO

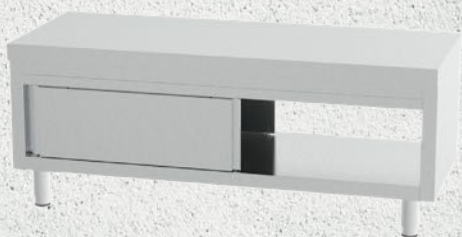

NE15M60602N1

	CON ENCIMERA SIN PETO		SIN ENCIMERA	
	WITH WORKTOP WITHOUT SPLASH BACK		WITHOUT WORKTOP	
MEDIDAS (MM) MEASURES	MODELO MODEL	PRECIO PRICE €	MODELO MODEL	PRECIO PRICE €
1000x600x600	NE10M60602N1	983	NE10M60802N0	789
1200x600x600	NE12M60602N1	1.069	NE12M60602N0	850
1400x600x600	NE14M60602N1	1.150	NE14M60602N0	909
1500x600x600	NE15M60602N1	1.195	NE15M60602N0	943
1600x600x600	NE16M60602N1	1.244	NE16M60602N0	979
1800x600x600	NE18M60602N1	1.325	NE18M60602N0	1.038
2000x600x600	NE20M60602N1	1.430	NE20M60602N0	1.121
2200x600x600	NE22M60602N1	1.514	NE22M60602N0	1.179
2400x600x600	NE24M60602N1	1.605	NE24M60602N0	1.248

GAMA 700



SIN ENCIMERA



NE15M60602N0

	CON ENCIMERA SIN PETO		SIN ENCIMERA	
	WITH WORKTOP WITHOUT SPLASH BACK		WITHOUT WORKTOP	
MEDIDAS (MM) MEASURES	MODELO MODEL	PRECIO PRICE €	MODELO MODEL	PRECIO PRICE €
1000x700x600	NE10M70602N1	1.024	NE10M70602N0	815
1200x700x600	NE12M70602N1	1.114	NE12M70602N0	878
1400x700x600	NE14M70602N1	1.201	NE14M70602N0	939
1500x700x600	NE15M70602N1	1.248	NE15M70602N0	974
1600x700x600	NE16M70602N1	1.300	NE16M70602N0	1.012
1800x700x600	NE18M70602N1	1.386	NE18M70602N0	1.073
2000x700x600	NE20M70602N1	1.497	NE20M70602N0	1.158
2200x600x600	NE22M70602N1	1.585	NE22M70602N0	1.220
2400x600x600	NE24M70602N1	1.681	NE24M70602N0	1.291

Mueble con Puertas Correderas Cabinet with sliding doors

ALTURA 850mm

GAMA 600



CON ENCIMERA CON PETO



NE15M60804N2

MEDIDAS (MM) MEASURES	CON ENCIMERA CON PETO WITH WORKTOP WITH SPLASH BACK		CON ENCIMERA SIN PETO WITH WORKTOP WITHOUT SPLASH BACK		SIN ENCIMERA WITHOUT WORKTOP	
	MODELO MODEL	PRECIO PRICE €	MODELO MODEL	PRECIO PRICE €	MODELO MODEL	PRECIO PRICE €
1000x600x850	NE10M60804N2	1.146	NE10M60804N1	1.077	NE10M60804N0	883
1200x600x850	NE12M60804N2	1.258	NE12M60804N1	1.185	NE12M60804N0	967
1400x600x850	NE14M60804N2	1.366	NE14M60804N1	1.289	NE14M60804N0	1.048
1500x600x850	NE15M60804N2	1.425	NE15M60804N1	1.345	NE15M60804N0	1.093
1600x600x850	NE16M60804N2	1.488	NE16M60804N1	1.406	NE16M60804N0	1.141
1800x600x850	NE18M60804N2	1.596	NE18M60804N1	1.510	NE18M60804N0	1.222
2000x600x850	NE20M60804N2	1.728	NE20M60804N1	1.638	NE20M60804N0	1.328
2200x600x850	NE22M60804N2	1.838	NE22M60804N1	1.744	NE22M60804N0	1.409
2400x600x850	NE24M60804N2	1.956	NE24M60804N1	1.858	NE24M60804N0	1.501

CON ENCIMERA SIN PETO



NE15M60804N1

GAMA 700



SIN ENCIMERA



NE15M60804N0

MEDIDAS (MM) MEASURES	CON ENCIMERA CON PETO WITH WORKTOP WITH SPLASH BACK		CON ENCIMERA SIN PETO WITH WORKTOP WITHOUT SPLASH BACK		SIN ENCIMERA WITHOUT WORKTOP	
	MODELO MODEL	PRECIO PRICE €	MODELO MODEL	PRECIO PRICE €	MODELO MODEL	PRECIO PRICE €
1000x700x850	NE10M70804N2	1.202	NE10M70804N1	1.134	NE10M70804N0	925
1200x700x850	NE12M70804N2	1.321	NE12M70804N1	1.249	NE12M70804N0	1.012
1400x700x850	NE14M70804N2	1.436	NE14M70804N1	1.359	NE14M70804N0	1.098
1500x700x850	NE15M70804N2	1.497	NE15M70804N1	1.419	NE15M70804N0	1.145
1600x700x850	NE16M70804N2	1.564	NE16M70804N1	1.484	NE16M70804N0	1.195
1800x700x850	NE18M70804N2	1.678	NE18M70804N1	1.594	NE18M70804N0	1.281
2000x700x850	NE20M70804N2	1.818	NE20M70804N1	1.729	NE20M70804N0	1.391
2200x700x850	NE22M70804N2	1.935	NE22M70804N1	1.842	NE22M70804N0	1.477
2400x700x850	NE24M70804N2	2.059	NE24M70804N1	1.963	NE24M70804N0	1.573

Mueble con Puertas Correderas Cabinet with sliding doors

ALTURA 600mm

GAMA 600



CON ENCIMERA CON PETO



NE15M60604N2

MEDIDAS (MM) MEASURES	CON ENCIMERA CON PETO WITH WORKTOP WITH SPLASH BACK		CON ENCIMERA SIN PETO WITH WORKTOP WITHOUT SPLASH BACK		SIN ENCIMERA WITHOUT WORKTOP	
	MODELO MODEL	PRECIO PRICE €	MODELO MODEL	PRECIO PRICE €	MODELO MODEL	PRECIO PRICE €
1000x600x600	NE10M60604N2	953	NE10M60604N1	884	NE10M60604N0	690
1200x600x600	NE12M60604N2	1.038	NE12M60604N1	965	NE12M60604N0	747
1400x600x600	NE14M60604N2	1.119	NE14M60604N1	1.042	NE14M60604N0	801
1500x600x600	NE15M60604N2	1.164	NE15M60604N1	1.084	NE15M60604N0	832
1600x600x600	NE16M60604N2	1.213	NE16M60604N1	1.132	NE16M60604N0	866
1800x600x600	NE18M60604N2	1.294	NE18M60604N1	1.208	NE18M60604N0	921
2000x600x600	NE20M60604N2	1.399	NE20M60604N1	1.309	NE20M60804N0	999
2200x600x600	NE22M60604N2	1.482	NE22M60604N1	1.388	NE22M60604N0	1.053
2400x600x600	NE24M60604N2	1.573	NE24M60604N1	1.475	NE24M60604N0	1.118

CON ENCIMERA SIN PETO

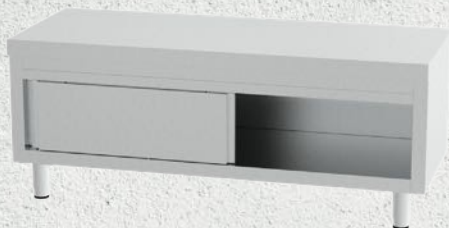

NE15M60604N1

GAMA 700



SIN ENCIMERA



NE15M60604N0

MEDIDAS (MM) MEASURES	CON ENCIMERA CON PETO WITH WORKTOP WITH SPLASH BACK		CON ENCIMERA SIN PETO WITH WORKTOP WITHOUT SPLASH BACK		SIN ENCIMERA WITHOUT WORKTOP	
	MODELO MODEL	PRECIO PRICE €	MODELO MODEL	PRECIO PRICE €	MODELO MODEL	PRECIO PRICE €
1000x700x600	NE10M70604N2	993	NE10M70604N1	925	NE10M70604N0	716
1200x700x600	NE12M70604N2	1.083	NE12M70604N1	1.011	NE12M70604N0	775
1400x700x600	NE14M70604N2	1.169	NE14M70604N1	1.093	NE14M70604N0	831
1500x700x600	NE15M70604N2	1.216	NE15M70604N1	1.138	NE15M70604N0	864
1600x700x600	NE16M70604N2	1.268	NE16M70604N1	1.188	NE16M70604N0	899
1800x700x600	NE18M70604N2	1.353	NE18M70604N1	1.269	NE18M70604N0	956
2000x700x600	NE20M70604N2	1.464	NE20M70604N1	1.375	NE20M70604N0	1.037
2200x700x600	NE22M70604N2	1.552	NE22M70604N1	1.459	NE22M70604N0	1.094
2400x700x600	NE24M70604N2	1.647	NE24M70604N1	1.551	NE24M70604N0	1.160

Mueble con Puertas Batientes

Hinged doors

ALTURA 850mm

GAMA 600



CON ENCIMERA CON PETO

NE15M60805N2



CON ENCIMERA SIN PETO

NE15M60805N1



SIN ENCIMERA

NE15M60805N0

MEDIDAS (MM) MEASURES	CON ENCIMERA CON PETO WITH WORKTOP WITH SPLASH BACK		CON ENCIMERA SIN PETO WITH WORKTOP WITHOUT SPLASH BACK		SIN ENCIMERA WITHOUT WORKTOP	
	MODELO MODEL	PRECIO PRICE €	MODELO MODEL	PRECIO PRICE €	MODELO MODEL	PRECIO PRICE €
600x600x850	NE60M60805N2	873	NE60M60805N1	812	NE60M60805N0	663
800x600x850	NE80M60805N2	1.031	NE80M60805N1	967	NE80M60805N0	795
1000x600x850	NE10M60805N2	1.138	NE10M60805N1	1.069	NE10M60805N0	875
1200x600x850	NE12M60805N2	1.249	NE12M60805N1	1.175	NE12M60805N0	957
1400x600x850	NE14M60805N2	1.407	NE14M60805N1	1.330		
1500x600x850	NE15M60805N2	1.465	NE15M60805N1	1.385		
1600x600x850	NE16M60805N2	1.526	NE16M60805N1	1.445		
1800x600x850	NE18M60805N2	1.633	NE18M60805N1	1.547		
2000x600x850	NE20M60805N2	1.816	NE20M60805N1	1.726		
2200x600x850	NE22M60805N2	1.924	NE22M60805N1	1.830		
2400x600x850	NE24M60805N2	2.041	NE24M60805N1	1.942		

GAMA 700



MEDIDAS (MM) MEASURES	CON ENCIMERA CON PETO WITH WORKTOP WITH SPLASH BACK		CON ENCIMERA SIN PETO WITH WORKTOP WITHOUT SPLASH BACK		SIN ENCIMERA WITHOUT WORKTOP	
	MODELO MODEL	PRECIO PRICE €	MODELO MODEL	PRECIO PRICE €	MODELO MODEL	PRECIO PRICE €
600x700x850	NE60M70805N2	915	NE60M70805N1	855	NE60M70805N0	696
800x700x850	NE80M70805N2	1.081	NE80M70805N1	1.017	NE80M70805N0	833
1000x700x850	NE10M70805N2	1.194	NE10M70805N1	1.126	NE10M70805N0	917
1200x700x850	NE12M70805N2	1.311	NE12M70805N1	1.239	NE12M70805N0	1.003
1400x700x850	NE14M70805N2	1.477	NE14M70805N1	1.400		
1500x700x850	NE15M70805N2	1.538	NE15M70805N1	1.459		
1600x700x850	NE16M70805N2	1.603	NE16M70805N1	1.522		
1800x700x850	NE18M70805N2	1.716	NE18M70805N1	1.632		
2000x700x850	NE20M70805N2	1.906	NE20M70805N1	1.817		
2200x700x850	NE22M70805N2	2.021	NE22M70805N1	1.929		
2400x700x850	NE24M70805N2	2.144	NE24M70805N1	2.048		

Mueble con Puertas Batientes Hinged doors

ALTURA 600mm

GAMA 600



CON ENCIMERA CON PETO



NE15M60605N2

MEDIDAS (MM) MEASURES	CON ENCIMERA CON PETO WITH WORKTOP WITH SPLASH BACK		CON ENCIMERA SIN PETO WITH WORKTOP WITHOUT SPLASH BACK		SIN ENCIMERA WITHOUT WORKTOP	
	MODELO MODEL	PRECIO PRICE €	MODELO MODEL	PRECIO PRICE €	MODELO MODEL	PRECIO PRICE €
600x600x600	NE60M60605N2	741	NE60M60605N1	681	NE60M60805N0	531
800x600x600	NE80M60605N2	868	NE80M60605N1	803	NE80M60605N0	632
1000x600x600	NE10M60605N2	948	NE10M60605N1	879	NE10M60605N0	685
1200x600x600	NE12M60605N2	1.031	NE12M60605N1	958	NE12M60605N0	740
1400x600x600	NE14M60605N2	1.158	NE14M60605N1	1.081		
1500x600x600	NE15M60605N2	1.202	NE15M60605N1	1.123		
1600x600x600	NE16M60605N2	1.250	NE16M60605N1	1.169		
1800x600x600	NE18M60605N2	1.330	NE18M60605N1	1.244		
2000x600x600	NE20M60605N2	1.480	NE20M60605N1	1.391		
2200x600x600	NE22M60605N2	1.562	NE22M60605N1	1.468		
2400x600x600	NE24M60605N2	1.651	NE24M60605N1	1.553		

CON ENCIMERA SIN PETO

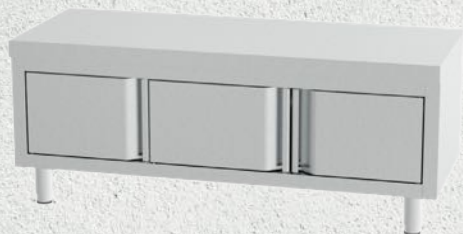

NE15M60605N1

GAMA 700



SIN ENCIMERA



NE15M60605N0

MEDIDAS (MM) MEASURES	CON ENCIMERA CON PETO WITH WORKTOP WITH SPLASH BACK		CON ENCIMERA SIN PETO WITH WORKTOP WITHOUT SPLASH BACK		SIN ENCIMERA WITHOUT WORKTOP	
	MODELO MODEL	PRECIO PRICE €	MODELO MODEL	PRECIO PRICE €	MODELO MODEL	PRECIO PRICE €
600x700x600	NE60M70605N2	772	NE60M70805N1	712	NE60M70805N0	553
800x700x600	NE80M70605N2	904	NE80M70605N1	839	NE80M70605N0	655
1000x700x600	NE10M70605N2	988	NE10M70605N1	920	NE10M70605N0	710
1200x700x600	NE12M70605N2	1.076	NE12M70605N1	1.004	NE12M70605N0	768
1400x700x600	NE14M70605N2	1.208	NE14M70605N1	1.131		
1500x700x600	NE15M70605N2	1.254	NE15M70605N1	1.176		
1600x700x600	NE16M70605N2	1.305	NE16M70605N1	1.225		
1800x700x600	NE18M70605N2	1.389	NE18M70605N1	1.305		
2000x700x600	NE20M70605N2	1.545	NE20M70605N1	1.457		
2200x700x600	NE22M70605N2	1.631	NE22M70605N1	1.539		
2400x700x600	NE24M70605N2	1.726	NE24M70605N1	1.629		

Encimeras Worktops

GAMA 600



CON ENCIMERA CON PETO



NE15E60018N2

CON ENCIMERA SIN PETO



NE15E60018N1

MEDIDAS (MM) MEASURES	CON ENCIMERA SIN PETO WITH WORKTOP WITHOUT SPLASH BACK		SIN ENCIMERA WITHOUT WORKTOP	
	MODELO MODEL	PRECIO PRICE €	MODELO MODEL	PRECIO PRICE €
400	NE04E60018N2	205	NE04E60018N1	141
500	NE05E60018N2	220	NE05E60018N1	154
600	NE06E60018N2	239	NE06E60018N1	170
700	NE07E60018N2	254	NE07E60018N1	183
800	NE08E60018N2	270	NE08E60018N1	197
900	NE09E60018N2	285	NE09E60018N1	210
1000	NE10E60018N2	301	NE10E60018N1	223
1100	NE11E60018N2	319	NE11E60018N1	239
1200	NE12E60018N2	335	NE12E60018N1	252
1300	NE13E60018N2	350	NE13E60018N1	265
1400	NE14E60018N2	366	NE14E60018N1	279
1500	NE15E60018N2	381	NE15E60018N1	292
1600	NE16E60018N2	400	NE16E60018N1	308
1700	NE17E60018N2	415	NE17E60018N1	321
1800	NE18E60018N2	431	NE18E60018N1	334
1900	NE19E60018N2	446	NE19E60018N1	347
2000	NE20E60018N2	462	NE20E60018N1	361
2100	NE21E60018N2	480	NE21E60018N1	376
2200	NE22E60018N2	496	NE22E60018N1	390
2300	NE23E60018N2	511	NE23E60018N1	403
2400	NE24E60018N2	527	NE24E60018N1	416
2500	NE25E60018N2	543	NE25E60018N1	429
2600	NE26E60018N2	561	NE26E60018N1	445
2700	NE27E60018N2	576	NE27E60018N1	458
2800	NE28E60018N2	592	NE28E60018N1	472

Encimeras Worktops

GAMA 700



CON ENCIMERA CON PETO



NE15E70018N2

CON ENCIMERA SIN PETO



NE15E70018N1

MEDIDAS (MM) MEASURES	CON ENCIMERA SIN PETO		SIN ENCIMERA	
	MODELO MODEL	PRECIO PRICE €	MODELO MODEL	PRECIO PRICE €
400	NE04E70018N2	213	NE04E70018N1	149
500	NE05E70018N2	230	NE05E70018N1	164
600	NE06E70018N2	249	NE06E70018N1	181
700	NE07E70018N2	266	NE07E70018N1	196
800	NE08E70018N2	283	NE08E70018N1	211
900	NE09E70018N2	300	NE09E70018N1	226
1000	NE10E70018N2	317	NE10E70018N1	240
1100	NE11E70018N2	337	NE11E70018N1	258
1200	NE12E70018N2	354	NE12E70018N1	272
1300	NE13E70018N2	371	NE13E70018N1	287
1400	NE14E70018N2	388	NE14E70018N1	302
1500	NE15E70018N2	405	NE15E70018N1	317
1600	NE16E70018N2	424	NE16E70018N1	334
1700	NE17E70018N2	441	NE17E70018N1	349
1800	NE18E70018N2	458	NE18E70018N1	363
1900	NE19E70018N2	475	NE19E70018N1	378
2000	NE20E70018N2	492	NE20E70018N1	393
2100	NE21E70018N2	512	NE21E70018N1	410
2200	NE22E70018N2	529	NE22E70018N1	425
2300	NE23E70018N2	546	NE23E70018N1	440
2400	NE24E70018N2	563	NE24E70018N1	454
2500	NE25E70018N2	580	NE25E70018N1	469
2600	NE26E70018N2	600	NE26E70018N1	486
2700	NE27E70018N2	617	NE27E70018N1	501
2800	NE28E70018N2	634	NE28E70018N1	516

Abierto 1 Cara y 3 Cajones · Open 1 side and 3 drawers

Cajones Derecha Drawers right

CON ENCIMERA CON PETO

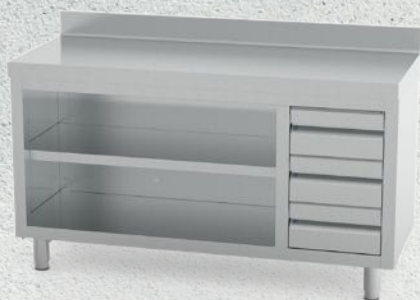

NE15M60808D2

GAMA 600



	CON ENCIMERA SIN PETO		SIN ENCIMERA	
	WITH WORKTOP WITHOUT SPLASH BACK		WITHOUT WORKTOP	
MEDIDAS (MM) MEASURES	MODELO MODEL	PRECIO PRICE €	MODELO MODEL	PRECIO PRICE €
1200x600x850	NE12M60808D2	1.410	NE12M60808D1	1.337
1400x600x850	NE14M60808D2	1.496	NE14M60808D1	1.419
1500x600x850	NE15M60808D2	1.544	NE15M60808D1	1.465
1600x600x850	NE16M60808D2	1.597	NE16M60808D1	1.515
1800x600x850	NE18M60808D2	1.683	NE18M60808D1	1.598
2000x600x850	NE20M60808D2	1.794	NE20M60808D1	1.704
2200x600x850	NE22M60808D2	1.883	NE22M60808D1	1.789
2400x600x850	NE24M60808D2	1.980	NE24M60808D1	1.882

CON ENCIMERA SIN PETO



NE12M60808D1

GAMA 700



	CON ENCIMERA SIN PETO		SIN ENCIMERA	
	WITH WORKTOP WITHOUT SPLASH BACK		WITHOUT WORKTOP	
MEDIDAS (MM) MEASURES	MODELO MODEL	PRECIO PRICE €	MODELO MODEL	PRECIO PRICE €
1200x700x850	NE12M70808D2	1.488	NE12M70808D1	1.416
1400x700x850	NE14M70808D2	1.579	NE14M70808D1	1.503
1500x700x850	NE15M70808D2	1.630	NE15M70808D1	1.552
1600x700x850	NE16M70808D2	1.684	NE16M70808D1	1.604
1800x700x850	NE18M70808D2	1.776	NE18M70808D1	1.692
2000x700x850	NE20M70808D2	1.892	NE20M70808D1	1.804
2200x700x850	NE22M70808D2	1.986	NE22M70808D1	1.894
2400x700x850	NE24M70808D2	2.087	NE24M70808D1	1.991

Abierto 1 Cara y 3 Cajones · Open 1 side and 3 drawers

Cajones izquierda Drawers left

CON ENCIMERA CON PETO

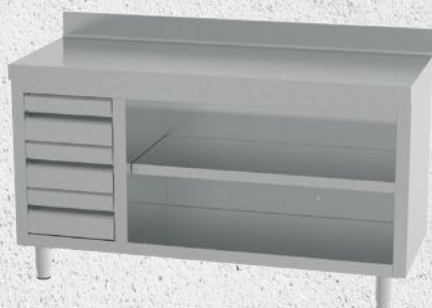

NE15M6080812

GAMA 600



MEDIDAS (MM) MEASURES	CON ENCIMERA SIN PETO WITH WORKTOP WITHOUT SPLASH BACK		SIN ENCIMERA WITHOUT WORKTOP	
	MODELO MODEL	PRECIO PRICE €	MODELO MODEL	PRECIO PRICE €
1200x600x850	NE12M6080812	1.410	NE12M6080811	1.337
1400x600x850	NE14M6080812	1.496	NE14M6080811	1.419
1500x600x850	NE15M6080812	1.544	NE15M6080811	1.465
1600x600x850	NE16M6080812	1.597	NE16M6080811	1.515
1800x600x850	NE18M6080812	1.683	NE18M6080811	1.598
2000x600x850	NE20M6080812	1.794	NE20M6080811	1.704
2200x600x850	NE22M6080812	1.883	NE22M6080811	1.789
2400x600x850	NE24M6080812	1.980	NE24M6080811	1.882

CON ENCIMERA SIN PETO



NE15M6080811

GAMA 700



MEDIDAS (MM) MEASURES	CON ENCIMERA SIN PETO WITH WORKTOP WITHOUT SPLASH BACK		SIN ENCIMERA WITHOUT WORKTOP	
	MODELO MODEL	PRECIO PRICE €	MODELO MODEL	PRECIO PRICE €
1200x700x850	NE12M7080812	1.488	NE12M7080811	1.416
1400x700x850	NE14M7080812	1.579	NE14M7080811	1.503
1500x700x850	NE15M7080812	1.630	NE15M7080811	1.552
1600x700x850	NE16M7080812	1.684	NE16M7080811	1.604
1800x700x850	NE18M7080812	1.776	NE18M7080811	1.692
2000x700x850	NE20M7080812	1.892	NE20M7080811	1.804
2200x700x850	NE22M7080812	1.986	NE22M7080811	1.894
2400x700x850	NE24M7080812	2.087	NE24M7080811	1.991

Correderas 1 Cara y 3 Cajones · *Runners 1 side and 3 drawers*

Cajones Derecha *Drawers right*

CON ENCIMERA CON PETO



NE15M60809D2

GAMA 600



MEDIDAS (MM) MEASURES	CON ENCIMERA SIN PETO WITH WORKTOP WITHOUT SPLASH BACK		SIN ENCIMERA WITHOUT WORKTOP	
	MODELO MODEL	PRECIO PRICE €	MODELO MODEL	PRECIO PRICE €
1200x600x850	NE12M60809D2	1.566	NE12M60809D1	1.493
1400x600x850	NE14M60809D2	1.677	NE14M60809D1	1.600
1500x600x850	NE15M60809D2	1.737	NE15M60809D1	1.658
1600x600x850	NE16M60809D2	1.802	NE16M60809D1	1.720
1800x600x850	NE18M60809D2	1.913	NE18M60809D1	1.827
2000x600x850	NE20M60809D2	2.048	NE20M60809D1	1.958
2200x600x850	NE22M60809D2	2.161	NE22M60809D1	2.067
2400x600x850	NE24M60809D2	2.282	NE24M60809D1	2.184

CON ENCIMERA SIN PETO



NE15M60809D1

GAMA 700



MEDIDAS (MM) MEASURES	CON ENCIMERA SIN PETO WITH WORKTOP WITHOUT SPLASH BACK		SIN ENCIMERA WITHOUT WORKTOP	
	MODELO MODEL	PRECIO PRICE €	MODELO MODEL	PRECIO PRICE €
1200x700x850	NE12M70809D2	1.644	NE12M70809D1	1.572
1400x700x850	NE14M70809D2	1.760	NE14M70809D1	1.684
1500x700x850	NE15M70809D2	1.822	NE15M70809D1	1.744
1600x700x850	NE16M70809D2	1.889	NE16M70809D1	1.809
1800x700x850	NE18M70809D2	2.005	NE18M70809D1	1.921
2000x700x850	NE20M70809D2	2.146	NE20M70809D1	2.057
2200x700x850	NE22M70809D2	2.264	NE22M70809D1	2.171
2400x700x850	NE24M70809D2	2.390	NE24M70809D1	2.293

Correderas 1 Cara y 3 Cajones · *Runners 1 side and 3 drawers*

Cajones izquierda *Drawers left*

CON ENCIMERA CON PETO



NE15M6080912

GAMA 600



	CON ENCIMERA SIN PETO		SIN ENCIMERA	
	WITH WORKTOP WITHOUT SPLASH BACK		WITHOUT WORKTOP	
MEDIDAS (MM) MEASURES	MODELO MODEL	PRECIO PRICE €	MODELO MODEL	PRECIO PRICE €
1200x600x850	NE12M6080912	1.566	NE12M6080911	1.493
1400x600x850	NE14M6080912	1.677	NE14M6080911	1.600
1500x600x850	NE15M6080912	1.737	NE15M6080911	1.658
1600x600x850	NE16M6080912	1.802	NE16M6080911	1.720
1800x600x850	NE18M6080912	1.913	NE18M6080911	1.827
2000x600x850	NE20M6080912	2.048	NE20M6080911	1.958
2200x600x850	NE22M6080912	2.161	NE22M6080911	2.067
2400x600x850	NE24M6080912	2.282	NE24M6080911	2.184

CON ENCIMERA SIN PETO



NE15M6080911

GAMA 700



	CON ENCIMERA SIN PETO		SIN ENCIMERA	
	WITH WORKTOP WITHOUT SPLASH BACK		WITHOUT WORKTOP	
MEDIDAS (MM) MEASURES	MODELO MODEL	PRECIO PRICE €	MODELO MODEL	PRECIO PRICE €
1200x700x850	NE12M7080912	1.644	NE12M7080911	1.572
1400x700x850	NE14M7080912	1.760	NE14M7080911	1.684
1500x700x850	NE15M7080912	1.822	NE15M7080911	1.744
1600x700x850	NE16M7080912	1.889	NE16M7080911	1.809
1800x700x850	NE18M7080912	2.005	NE18M7080911	1.921
2000x700x850	NE20M7080912	2.146	NE20M7080911	2.057
2200x700x850	NE22M7080912	2.264	NE22M7080911	2.171
2400x700x850	NE24M7080912	2.390	NE24M7080911	2.293

Estanterías de Pared · Wall Shelves

Estantería para Microondas · Microwave bracket



MEDIDAS (MM) MEASURES	MODELO MODEL	PRECIO PRICE €
600 x 400	NE06B40028	Consultar
600 x 550	NE06B50028	Consultar

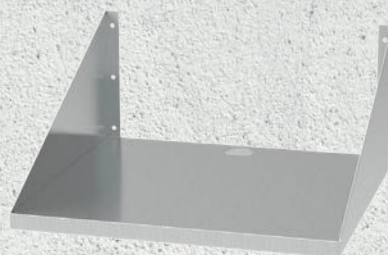

Estantería fondo 250 · Shelf Depth 250 Estantería fondo 400 · Shelf Depth 400



MEDIDAS (MM) MEASURES	MODELO MODEL	PRECIO PRICE €
600 x 250	NE06B20026	Consultar
800 x 250	NE08B20026	Consultar
1000 x 250	NE10B20026	Consultar
1200 x 250	NE12B20026	Consultar
1400 x 250	NE14B20026	Consultar
1500 x 250	NE15B20026	Consultar
1600 x 250	NE16B20026	Consultar
1800 x 250	NE18B20026	Consultar
2000 x 250	NE20B20026	Consultar



MEDIDAS (MM) MEASURES	MODELO MODEL	PRECIO PRICE €
600 x 400	NE06B40026	Consultar
800 x 400	NE08B40026	Consultar
1000 x 400	NE10B40026	Consultar
1200 x 400	NE12B40026	Consultar
1400 x 400	NE14B40026	Consultar
1500 x 400	NE15B40026	Consultar
1600 x 400	NE16B40026	Consultar
1800 x 400	NE18B40026	Consultar
2000 x 400	NE20B40026	Consultar



Estantería con cartelas invertidas fondo 250 Shelf with inverted Brackets depth 250 Estantería con cartelas invertidas fondo 400 Shelf with inverted Brackets depth 400



MEDIDAS (MM) MEASURES	MODELO MODEL	PRECIO PRICE €
600 x 250	NE06B20027	Consultar
800 x 250	NE08B20027	Consultar
1000 x 250	NE10B20027	Consultar
1200 x 250	NE12B20027	Consultar
1400 x 250	NE14B20027	Consultar
1500 x 250	NE15B20027	Consultar
1600 x 250	NE16B20027	Consultar
1800 x 250	NE18B20027	Consultar
2000 x 250	NE20B20027	Consultar



MEDIDAS (MM) MEASURES	MODELO MODEL	PRECIO PRICE €
600 x 400	NE06B40027	Consultar
800 x 400	NE08B40027	Consultar
1000 x 400	NE10B40027	Consultar
1200 x 400	NE12B40027	Consultar
1400 x 400	NE14B40027	Consultar
1500 x 400	NE15B40027	Consultar
1600 x 400	NE16B40027	Consultar
1800 x 400	NE18B40027	Consultar
2000 x 400	NE20B40027	Consultar



Mueble neutro colgante abierto a una cara

Mueble neutro colgante abierto a una cara



MEDIDAS (MM) MEASURES	MODELO MODEL	PRECIO PRICE €
800 x 400 x 600	NE08C40603N0	Consultar
1000 x 400 x 600	NE10C40603N0	Consultar
1200 x 400 x 600	NE12C40603N0	Consultar
1400 x 400 x 600	NE14C40603N0	Consultar
1600 x 400 x 600	NE16C40603N0	Consultar

Mueble neutro colgante corredero a una cara

Mueble neutro colgante corredero a una cara



MEDIDAS (MM) MEASURES	MODELO MODEL	PRECIO PRICE €
800 x 400 x 600	NE08C40604N0	Consultar
1000 x 400 x 600	NE10C40604N0	Consultar
1200 x 400 x 600	NE12C40604N0	Consultar
1400 x 400 x 600	NE14C40604N0	Consultar
1600 x 400 x 600	NE16C40604N0	Consultar

Armario de pie abierto con puertas correderas

Armario de pie abierto con puertas correderas



MEDIDAS (MM) MEASURES	MODELO MODEL	PRECIO PRICE €
1200x600x1900	NE12A61904N0	Consultar
1400x600x1900	NE14A61904N0	Consultar
1600x600x1900	NE16A61904N0	Consultar

Dispensadores de Pan, Vasos y Cuberteria Bread, glass and cutterly dispensers Modelos · Models

Cubertero y Panero para Caja · Box cutterly and bread



EEPN



MODELO MODEL	MEDIDAS MEASURES (MM)	PRECIO PRICE €
EEPN	620 x 650 x 690	794

Dispensador de Pan y Vasos · Bread, glass cups and cutterly dispensers



SSPN620



SSPN



SSPN800



SSPN1400

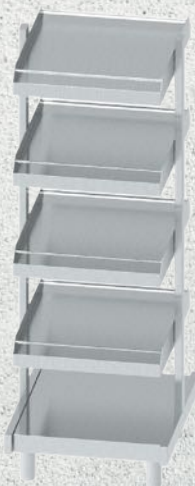

SSEST620



MODELO MODEL	MEDIDAS MEASURES (MM)	PRECIO PRICE €
SSPN620	620 x 700 x 1500	1.362
SSPN	620 x 650 x 450	644
SSPN800	800 x 700 x 1500	1.867
SSPN1400	1400x 700 x 1500	3.167
SSEST620	620 x 700 x 1360	1.405

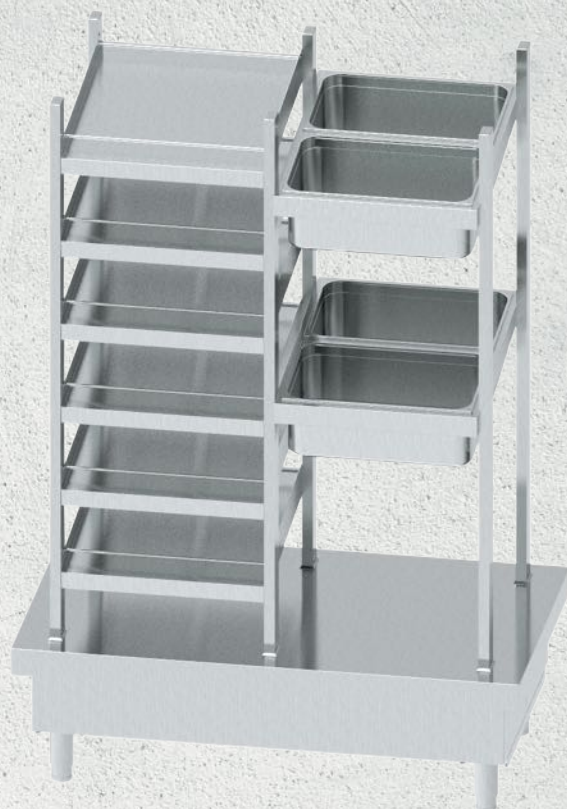

SSPN1400

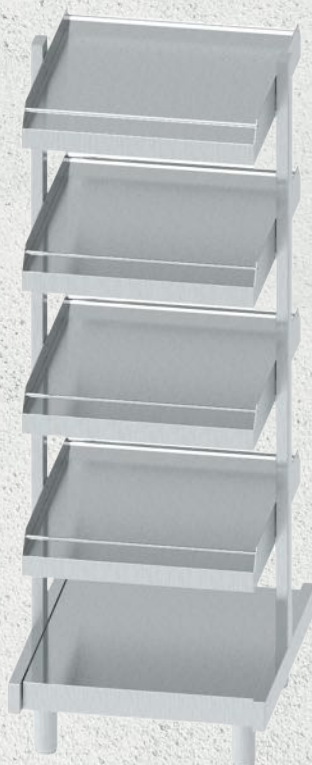

SSEST620

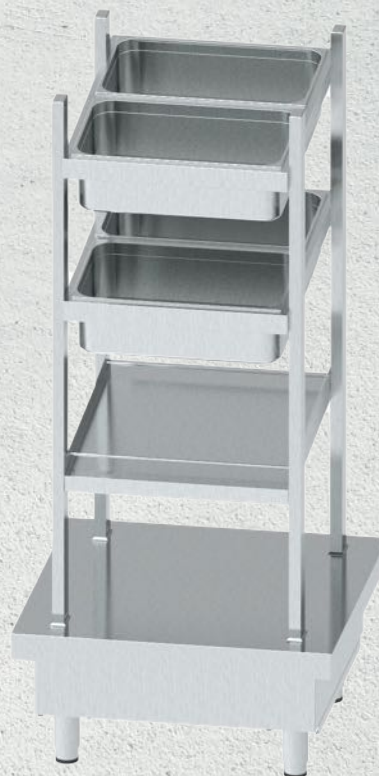

SSPN800



08. ACCCE



CHAFING 4800x0020

ESORIOS



Los mejores *complementos*

The best accessories



Grifo de Ducha · Shower Taps

Gama Completa de Grifos de Ducha · Complete range of shower taps

Modelos · Models



GF002



GF003



GF0012



GF013



GF014



GF015



GF016



GF017



GF018



GF019



GF020



GF021



GF022



GF023

- Fabricados en latón cromado de alta densidad y gran espesor
- Incluyen regulación de caudal y válvula anti retorno.
- Latiguillos flexibles y accesorios para su instalación.

- *Manufactured in high density, thick, chrome-plated brass.*
- *Includes flow regulation and non-return valve.*
- *Flexible lines and accessories for installation.*

MODELO Models	DESCRIPCIÓN	DESCRIPTION	PVP €
GF002	Mezcladora de un agujero h=440mm con agujero pivotante y ducha de doble chorro apta para uso doméstico/en bares	<i>One hole mixer h=440mm with swinging spout and dual jet shower suitable for domestic/bar use</i>	316
GF003	Mezcladora de un agujero h=445mm con pivote pivotante, apta para uso doméstico/barra	<i>One hole mixer h=445mm with swinging spout, suitable for domestic/bar use</i>	295
GF012	Kit de ducha con muelle, flexo, empalme de latón y mango de ducha básico	<i>Kit shower with spring, flexible hose, brass junction and basic shower hand</i>	180
GF013	Kit de ducha con muelle, flexo, empalme de latón y mango de ducha premium	<i>Kit shower with spring, flexible hose, brass junction and premium shower hand</i>	193
GF014	Unidad de prelavado de un orificio con mango redondo y mango de ducha básico	<i>One hole pre-rinse unit with round handle and basic shower hand</i>	223
GF015	Unidad de prelavado de un orificio con mango redondo y mango de ducha premium	<i>One hole pre-rinse unit with round handle and premium shower hand</i>	234
GF016	Mezclador prelavado de un orificio con caño giratorio, palanca clínica de plástico (pa6) y mango de ducha básico	<i>One hole pre-rinse unit mixer with swinging spout, plastic (pa6) clinical lever and basic shower hand</i>	362
GF017	Mezclador prelavado de un orificio con caño giratorio, palanca clínica de plástico (pa6) y mango de ducha premium	<i>One hole pre-rinse unit mixer with swinging spout, plastic (pa6) clinical lever and premium shower hand</i>	373
GF018	Mezclador prelavado de un orificio con palanca corta cromada, versión mini	<i>One hole pre-rinse unit mixer with chromed short lever handle, mini version</i>	210
GF019	Unidad de prelavado de un orificio con mango de palanca, versión mini	<i>One hole pre-rinse unit with lever handle, mini version</i>	197
GF020	Unidad de enjuague previo de un orificio con caño en el centro del tubo, asa de estrella cromada y mango de ducha básico	<i>One hole pre-rinse unit with spout in the middle of the tube, chromed star handle and basic shower hand</i>	278
GF021	Unidad de enjuague previo de un orificio con caño en el centro del tubo, asa de estrella cromada y mango de ducha premium	<i>One hole pre-rinse unit with spout in the middle of the tube, chromed star handle and premium shower hand</i>	289
GF022	Unidad de prelavado de dos agujeros montada en la pared con caño giratorio en el centro de tubo metálico, maneta redonda y mango de ducha básico. Base de rueda de 150 mm con tolerancia de ± 20 mm	<i>Two holes pre-rinse unit wall mounted with swinging spout in the middle of metal tube, round handle and basic shower hand. 150mm wheelbase with ± 20mm tolerance</i>	276
GF023	Unidad de pre-enjuague de dos agujeros montada en la pared con caño oscilante en el centro de tubo de metal, mango redondo y mango de ducha premium. Base de rueda de 150 mm con tolerancia de ± 20 mm	<i>Two holes pre-rinse unit wall mounted with swinging spout in the middle of metal tube, round handle and premium shower hand. 150mm wheelbase with ± 20mm tolerance</i>	287

Grifos Industriales · Accesorios · Kit
Industrial Tap · Accessories · Kit



GF001



GF004



GF005



GF006



GF007



GF008



GF009



GF010



GF011

Accesorios



GF024



GF026



GF027



GF028

Kit



GF029



GF030



GF031



GF032

Grifos Industriales · Accesorios · Kit Industrial Tap · Accessories · Kit

MODELO Models	DESCRIPCIÓN	DESCRIPTION	PVP €
GF001	Caño en "u" cromado +e3:e26ø18x180	<i>Chromed "u" spout +e3:e26ø18x180</i>	17
GF004	Grifo un agujero caño "c" ø18x250, maneta estrella	<i>One hole tap "c" spout ø18x250, star handle</i>	76
GF005	Mezclador de un orificio con palanca clínica de plástico (pa6), caño giratorio y ducha extraíble	<i>One hole mixer with plastic (pa6) clinical lever, swinging spout and extractable shower</i>	143
GF006	Mezclador de un orificio con palanca clínica de plástico (pa6) y caño giratorio	<i>One hole mixer with plastic (pa6) clinical lever and swinging spout</i>	160
GF007	Mezclador de un agujero con palanca clínica de plástico (pa6), pico pivotante longitud 215mm	<i>One hole mixer with plastic (pa6) clinical lever, swinging spout lenght 215mm</i>	89
GF008	Mezclador de un agujero con palanca clínica de plástico (pa6), pico pivotante longitud 320mm	<i>One hole mixer with plastic (pa6) clinical lever, swinging spout lenght 320mm</i>	137
GF009	Grifo de dos agujeros con caño "c" giratorio ø18x300, maneta redonda. Base de 155mm	<i>Two holes tap with swinging "c" spout ø18x300, round handle. 155mm wheelbase</i>	130
GF010	Grifo de pared de dos agujeros con pico pivotante ø18x300, mango redondo. Base de rueda 150mm	<i>Two holes wall mounted tap with swinging "s" spout ø18x300, round handle. 150mm wheelbase</i>	81
GF011	Grifo de pared de dos orificios con caño en "c" giratorio ø20x300, mango redondo. 203,20mm base de rueda	<i>Two holes wall mounted tap with swinging "c" spout ø20x300, round handle. 203,20mm wheelbase</i>	120
GF024	Enrollador de manguera - 5m - con pistola spray	<i>Wall mounted hose reel - 5m with nito spray gun</i>	715
GF026	Enrollador de manguera - 5m - con pistola	<i>Wall mounted hose reel - 5m - nito gun</i>	434
GF027	Mezcladora de pie con dispositivo de bloqueo	<i>Floor mounted foot operated mixer with locking device</i>	418
GF028	Mezcladora progresiva de pie	<i>Floor mounted foot operated progressive mixer</i>	164
GF029	Kit grifo accionado con el pie agua fría con caño giratorio en "u" ø18x180	<i>Kit foot operated tap cold water with swinging "u" spout ø18x180</i>	155
GF030	Kit mezcladora progresiva accionada a pie con boquilla pivotante "u" ø18x250	<i>Kit foot operated progressive mixer with swinging spout "u" ø18x250</i>	219
GF031	Kit mezclador a pie con boquilla pivotante en "u" ø18x180	<i>Kit foot operated mixer with swinging "u" spout ø18x180</i>	223
GF032	Kit mezcladora progresiva de pie con bloqueo, pico giratorio en "u" ø18x180	<i>Kit foot operated progressive mixer with locking device, swinging "u" spout ø18x180</i>	556

Carritos y Almacenaje · Trolleys and storage

CÓDIGO CODE	DESCRIPCIÓN DESCRIPTION	PVP €
4900x0001	Portaplatos ajustable serie s /4 torres color gris <i>Adjustable plate holder series s /4 towers grey colour</i>	1.576
4900x0002	Pack 4 torres ajustables para carro 4900x0001 <i>Pack 4 adjustable towers for trolley 4900x0001</i>	398
4900x0003	Carro de servicio ligero con baldas 62 x 40 cm - 96,5 x 41 x 83,5 cm negro <i>Light service trolley with buckets 62 x 40 cm - 96.5 X 41 x 83.5 Cm black</i>	268
4900x0004	Carro de servicio ligero con baldas 80 x 52 cm - 101,5 x 54 x 95 cm negro <i>Light service trolley with buckets 80 x 52 cm - 101,5 x 54 x 95 cm black</i>	397
4900x0005	Carro de servicio cart pro color negro <i>Cart pro service trolley black</i>	1.610
4900x0006	Cubo pequeño de conexión rápida color negro <i>Small quick connect bucket black colour</i>	139
4900x0007	Cubo grande de conexión rápida color negro <i>Large quick connect bucket black</i>	158
4900x0008	Carro de alimentación gn 1/1 para 18 bandejas 1/1 <i>Food trolleys gn 1/1 for 18 trays 1/1</i>	675
4900x0009	Carro de alimentación gn 2/1 para 36 bandejas 1/1 <i>Food trolleys gn 2/1 trolley for 36 trays 1/1</i>	713
4900x0010	Cubiertas de vinilo de tamaño completo para carro gn 1/1 <i>Full size vinyl covers for gn 1/1 trolleys</i>	235
4900x0011	Cubiertas de vinilo de tamaño completo para el carro gn 2/1 <i>Full size vinyl covers for the gn 2/1 trolley</i>	265



Carritos y Almacenaje · Trolleys and storage



4900x0005



4900x0006



4900x0007



4900x0008

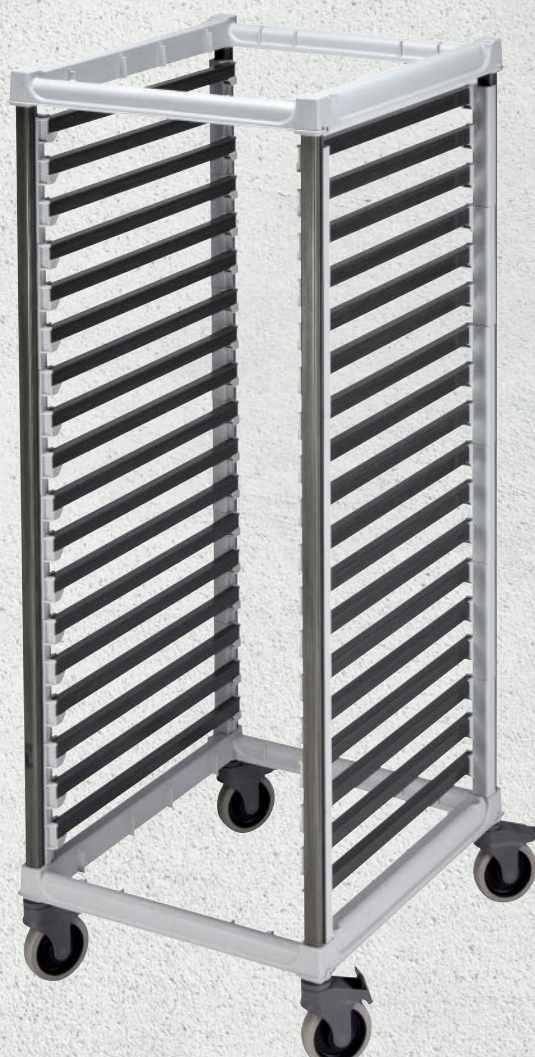

4900x0009



4900x0010

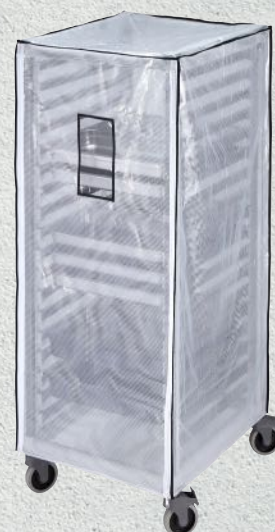

4900x0011

Estantes · Shelves

CATEGORÍA CATEGORY	CÓDIGO CODE	DESCRIPCIÓN DESCRIPTION	PVP €
ESTANTES	4800X0001	Estante triple 6 para 24x24 cm <i>Etagere sea 3 tier 6 holes scotch (for 24*24cm)</i>	448
ESTANTES	4800X0002	Estante triple 16 para 14x14, 10x10 y 24x24 cm <i>Shelves 3 tiers 16 (for 14x14, 10x10 and 24x24cm)</i>	448
ESTANTES	4800X0003	Estante de vasos para buffet doble 62x35 h:20 cm <i>Buffet glass stand 2 tier nostalgia (62*35*h:20 cm)</i>	556
ESTANTES	4800X0004	Estante de vasos para buffet triple 60x40 h:48 cm <i>Buffet glass stand 3 tier (60*40*h:48 cm)</i>	589
ESTANTES	4800X0005	Lámpara de calor plato redondo ø50 h:64 <i>Carving unit ø50 h:64 (with lamp chamber) (demounted)</i>	557
ESTANTES	4800X0006	Lámpara de calor plato cuadrado 50x50 h:64 <i>Carving unit 50*50 h:64 (with lamp chamber) (demounted)</i>	557
ESTANTES	4800X0023	Soporte cubiertos (ø:13cm h:14cm) <i>Spoon stand sea 3 floor 3 holes (container ø:13cm h:14cm)</i>	470
ESTANTES	4800X0024	Soporte básico 25x12,5 h:9cm <i>Spoon standl - chair 25*12,5h:9cm</i>	86



4800x0001



4800x0002



4800x0003
4800x0004



4800x0005



4800x0006



4800x0023



4800x0024

Chafing · Chafing

CATEGORÍA CATEGORY	CÓDIGO CODE	DESCRIPCIÓN DESCRIPTION	PVP €
CHAFING	4800X0009	Chafing dish gn 1/1 9 lt eléctrico <i>Chafing dish gn 1/1 9lt electrical</i>	943
CHAFING	4800X0010	Chafing dish gn 1/1 9 lt para calor en gel <i>Chafing dish gn 1/1 9lt jelly</i>	851
CHAFING	4800X0020	Chafing de cristal gn1/1 hidráulico	1.136
CHAFING	4800X0021	Resistencia chafing <i>Electrical heater 750w 250v</i>	117
CHAFING	4800X0022	Chafing de cristal gn 2/3 hidráulico	898



4800x0009



4800x0020



4800x0010



4800x0021



4800x0022

Dispensadores · *Dispenser*

CATEGORÍA CATEGORY	CÓDIGO CODE	DESCRIPCIÓN DESCRIPTION	PVP €
DISPENSADORES	4800X0011	Dispensador de miel vertical 4,7 lt h:57,5 cm <i>Honey Dispenser Lego Vertical Glass 4.7 Liter H:57,5 cm</i>	294
DISPENSADORES	4800X0013	Dispensador de cereal simple <i>Cereal Dispenser Single</i>	244
DISPENSADORES	4800X0014	Dispensador de cereal doble <i>Cereal Dispenser Double</i>	492
DISPENSADORES	4800X0015	Dispensador de cereal triple <i>Cereal Dispenser Triple</i>	682
DISPENSADORES	4800X0016	Dispensador de zumo simple 7 litros <i>Juice Dispenser 7 Lt</i>	341
DISPENSADORES	4800X0017	Dispensador de zumo doble 7 litros (14l) <i>Fruit Juice Dispenser Double 7*2 Lt</i>	605
DISPENSADORES	4800X0018	Dispensador de leche simple 7 litros <i>Milk Dispenser 7 Lt</i>	341
DISPENSADORES	4800X0019	Dispensador térmico (para café, té o leche) <i>Heated dispenser classic</i>	438



4800x0013



4800x0015



4800x0014



4800x0016



4800x0018



4800x0017



4800x0019



4800x0011

Lámparas de calor · Heat lamp

CATEGORÍA CATEGORY	CÓDIGO CODE	DESCRIPCIÓN DESCRIPTION	PVP €
LÁMPARAS DE CALOR	4800X0026	LAMPARA CALOR MLA-17-C 150W PLATA	227
LÁMPARAS DE CALOR	4800X0027	LAMPARA CALOR MLA-25-S (acero) 150W	296
LÁMPARAS DE CALOR	4800X0028	LAMPARA CALOR MLA-25-ESB (negro) 150W	296
LÁMPARAS DE CALOR	4800X0029	LAMPARA CALOR MLA-25-B (bronce) 150w	296
LÁMPARAS DE CALOR	4800X0030	LAMPARA CALOR MLA-25-G (oro) 150w	296
LÁMPARAS DE CALOR	4800X0031	LAMPARA CALOR BASE CUADRADA(MLS-2020PC) 250W	410
LÁMPARAS DE CALOR	4800X0032	LAMPARA CALOR REDONDA (MGP40PC) 750W	960
LÁMPARAS DE CALOR	4800X0033	LAMPARA CALOR MLA-17-G 150W ORO	227
LÁMPARAS DE CALOR	4800X0034	LAMPARA CALOR MLA-17-B 150W BRONCE	227
LÁMPARAS DE CALOR	4800X0035	LAMPARA CALOR MLA-17-ESB 150W ROJA	227





4800x0026



4800x0033



4800x0034



4800x0035



4800x0027



4800x0028



4800x0029



4800x0030



4800x0031



4800x0032

NOTAS

NOTES

DISFRUTA

ENJOY

friBuffet

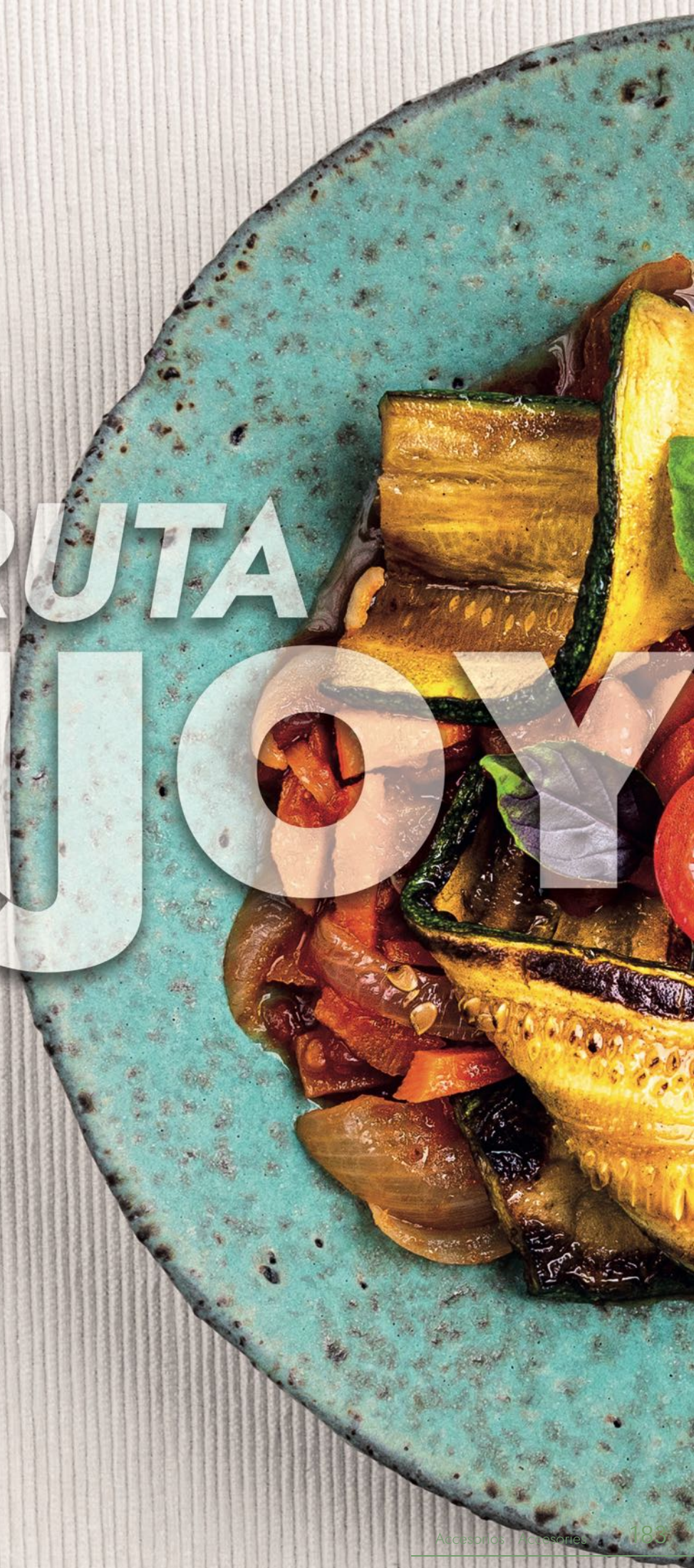



GRUPO 
Infrico®

friBuffet

Ctra. de Aguilar a A-318 por Moriles, km 15,5 - A-3132

CP 14900 LUCENA, Córdoba - España

Tel: 0034 957 51 30 68

info@fribuffet.com



www.fribuffet.com